



# Product Manual

*The Essential Guide for  
Safety Teams and  
Instrument Operators*

Edition: 20

February 03, 2025

Part Number: 17156830-1

**INDUSTRIAL**  
**SCIENTIFIC**

**NEED HELP?**  
SCAN OR CLICK HERE  
TO CONTACT US



**Air-Met Scientific**  
[www.airmet.com.au](http://www.airmet.com.au)

Industrial Scientific Corporation, Pittsburgh, PA, USA

Industrial Scientific Co., Ltd. Shanghai, China

© 2015, 2016, 2017, 2018, 2019, 2020, 2021, 2022, 2023, 2024, 2025 Industrial Scientific Corporation

All rights reserved. Published 2025.

Revision 23



[www.indsci.com/ventispro](http://www.indsci.com/ventispro)

# Contents

General Information .....	1
Certifications .....	1
Warnings and Cautionary Statements .....	3
Recommended Practices .....	8
Instrument maintenance .....	8
First use .....	10
Wearing the instrument .....	10
Cleaning the instrument exterior .....	10
Remote sampling .....	10
Cold-weather operation .....	12
Wireless .....	12
Product Information .....	15
Instrument Overview .....	15
Personal Protection and Connected Safety .....	16
Personal protection .....	16
Connected Safety .....	16
Key Features .....	17
Alarms .....	17
Connected safety .....	18
Display options .....	18
Security and protection .....	19
Technologies .....	19
Compatibility .....	19
Sensors and installation locations .....	19
Batteries .....	23
Gateways .....	24
iAssign accessories .....	24
Other compatibility items .....	25
Specifications .....	26
Instrument .....	26
Battery specifications .....	27
Sensor specifications .....	27
Getting Started .....	49
Unpacking the Instrument .....	49
Hardware Overview .....	50
Display Overview .....	52
Power On .....	59
Power Off .....	62

Settings .....	65
Guidelines .....	65
Accessing Settings .....	65
Settings Menus .....	66
Connected Safety Settings .....	66
Examples for Working in Settings .....	67
Reviewing and Editing Settings .....	69
Maintenance menu .....	70
Start-up menu .....	73
Operation menu .....	74
Alarm menu .....	76
Sensor menu .....	78
Admin menu .....	81
Wireless menu .....	83
Operation .....	87
The Instrument Buttons .....	87
The Instrument Display .....	88
Operating the Instrument .....	89
Wearing the Instrument .....	92
iAssign Accessories .....	92
iAssign Tags and Beacon .....	92
Standby Clip .....	93
LENS Wireless .....	94
LENS instrument basics .....	94
Using Upgrade Cards .....	95
Joining a LENS group .....	95
Leaving a LENS group .....	96
Peer gas readings .....	97
Live-monitoring Status .....	97
Messaging (Cellular Battery Option) .....	98
Man-down .....	98
Disabled .....	99
Standby .....	99
Alarms and Warnings At-a-glance .....	99
Alarms .....	99
Warnings .....	100
Alarms, Warnings, and Notifications .....	103
Overview .....	103
Alarms .....	103

Warnings .....	107
Indicators .....	109
Failures and Errors .....	110
<b>Maintenance .....</b>	<b>113</b>
Guidelines .....	113
Zero, Calibration, Bump Test, Response and Recovery Time Testing .....	113
Supplies and Preparation .....	114
Instruction .....	115
<b>Service and Warranty .....</b>	<b>121</b>
Service .....	121
Guidelines .....	121
Supplies .....	121
Instruction .....	122
Warranty .....	134
Limitation of Liability .....	134
<b>Appendix A .....</b>	<b>135</b>
Supplemental Information about Gases and Sensors .....	135
Toxic Gases .....	135
Combustible Gases .....	136
<b>Appendix B .....</b>	<b>138</b>
How to program a wi-fi battery-equipped Ventis Pro .....	138
<b>Appendix C .....</b>	<b>140</b>
Marking Requirements .....	140
ATEX, and Workplace Atmosphere Gas Performance .....	141
<b>Appendix D .....</b>	<b>142</b>
Certification Standards .....	142
<b>Appendix E .....</b>	<b>143</b>
Alarms, Possible Causes, and Relative Signal Intensity .....	143
Charger/Datalink Indicator .....	144
<b>Contact Information .....</b>	<b>145</b>

# Tables and Figures

Table 1.1 Hazardous-area certifications .....	1
Table 1.2 Wireless certifications .....	3
Table 1.3 Warnings and cautionary statements.....	3
Table 1.4 Recommended frequencies for instrument maintenance .....	9
Table 1.5 Minimum sample time for common sample-line lengths .....	12
Table 1.6 Range guidelines for wireless connections.....	13
Figure 2.1 Industrial Scientific connected safety.....	17
Figure 2.2.A Sensor compatibility and installation locations for the Ventis Pro4 .....	20
Figure 2.2.B Sensor compatibility and installation locations for the Ventis Pro5 .....	21
Table 2.1 Sensor compatibility and installation locations.....	22
Table 2.2 Battery compatibility .....	23
Table 2.3 Ventis Pro Gateway compatibility .....	24
Table 2.4 iAssign accessories .....	25
Table 2.5 Instrument and pump specifications .....	26
Table 2.6 Battery specifications .....	27
Table 2.7 Sensor specifications .....	28
Table 3.1 Package contents .....	49
Figure 3.1.A Hardware overview diffusion instrument .....	50
Figure 3.1.B Hardware overview aspirated instrument .....	51
Figure 3.2.A Reading the display during operation.....	54
Figure 3.2.B Reading the display during an event (warning or alarm).....	56
Figure 3.2.C Reading the display during maintenance .....	56
Figure 3.2.D Reading the display while working in settings.....	57
Figure 3.3 Power on.....	62
Figure 3.4 Power off.....	62
Table 4.1 Settings menus .....	66
Table 4.2 Ventis Pro-gateway firmware and settings requirements.....	67
Figure 4.1.A Example for editing a single-item setting.....	68
Figure 4.1.B Example for editing a multi-item setting .....	69
Figure 4.2.A Navigating and using maintenance options.....	72
Figure 4.2.B Navigating and editing start-up settings .....	73
Figure 4.2.C Navigating and editing operation settings .....	75
Figure 4.2.D Navigating and editing alarm settings .....	78
Table 4.3 Deadbands.....	79
Figure 4.2.E Navigating and editing sensor settings.....	80
Figure 4.2.F Navigating and editing admin settings.....	83
Figure 4.2.G Navigating and editing wireless settings .....	86
Figure 5.1 Using the buttons during operation.....	88
Figure 5.2 Home .....	89
Figure 5.3 Operation instruction.....	91

Figure 5.4 Using iAssign Tags .....	93
Figure 5.5 Operation display screen (Ventis Pro with Standby Clip) .....	94
Figure 5.6 LENS group peer-instrument locations .....	95
Figure 5.7 Join a LENS group via pairing .....	96
Figure 5.8 Leave a LENS group .....	97
Figure 5.9 Access peer gas readings .....	97
Table 5.1 Live-monitoring connection status .....	98
Table 6.1 Alarm events (list) .....	104
Figure 6.1 Alarm events (display screens).....	107
Table 6.2 Warnings (list) .....	108
Figure 6.2 Warnings (display screens) .....	109
Table 6.3 Failures and errors.....	110
Table 6.4 Critical errors.....	111
Figure 7.1 Maintenance supplies and preparation.....	114
Figure 7.2.A Zeroing instruction.....	115
Figure 7.2.B Calibration instruction.....	116
Figure 7.2.C Bump testing instruction.....	117
Figure 7.2.D Response time testing.....	118
Figure 7.2.E Recovery time testing.....	119
Table 7.1 Calibration failure: possible causes and recommendations.....	120
Figure 8.1 Instrument diagram.....	122
Figure 8.2 Pump module diagram.....	123
Table 8.1 Instrument and pump module parts list.....	124
Figure 8.3 Service Tasks .....	133
Table A.1 Cross-sensitivity guidelines (%).....	135
Table A.2 LEL correlation factors for the sensors 17155304-K, -L, and -M.....	136
Table A.3 LEL correlation factors <sup>a</sup> for the sensor 17155304-U, 17155304-UA .....	137
Table D.1 Applicable Certification Standards .....	142
Table E.1 Alarms with symbols and signal intensity .....	143
Table E.2 Charging/Datalink Pattern .....	144



## General Information

Certifications

Warnings and Cautionary Statements

Recommended Practices

### Certifications

Certifications for the Ventis® Pro4 Multi-Gas Monitor and Ventis® Pro5 Multi-Gas Monitor, at the time of this document's publication, are listed below in Tables 1.1 and 1.2. To determine the hazardous-area classifications for which an instrument is certified, refer to its label or the instrument order.

Table 1.1 Hazardous-area certifications

Certifying Body (CB)	Area Classifications	Standards	Approved Temperature Range
ANZEx	Ex ia I Ma and Ex ia IIC T4 Ga	IEC 60079-0:2017	-40 °C to +50 °C (-40 °F to +122 °F)
	Ex ia I Ma and Ex db ia IIC T4 Gb with MSH2ia sensor	IEC 60079-1:2014 IEC 60079-11:2011	
	Ex db ia I Mb and Ex db IIC T4 Gb with MSH-P IR sensor		-20 °C to +50 °C (-4 °F to +122 °F)
ATEX <sup>a</sup>	Ex ia I Ma	EN IEC 60079-0:2018	-40 °C to +50 °C (-40 °F to +122 °F)
	Ex ia IIC T4 Ga	EN 60079-1:2014	
	Ex db ia I Ma with IR sensor	EN 60079-11:2012	-20 °C to +50 °C (-4 °F to +122 °F)
	Ex db ia IIC T4 Gb with IR sensor	EN 50303:2000	
	Equipment Group and Category: I M1, II 1G, and II 2G	EN 60079-26:2015	
CSA <sup>b</sup>	Class I, Division 1, Groups A, B, C, and D, Temperature Class T4	CSAC22.2 No. 60079-0 CAN/CSA-C22.2 No. 61010-1-12	-40 °C to +50 °C (-40 °F to +122 °F)
	Class I, Zone 1, Ex db ia IIC, Temperature Class T4	CSAC22.2 No. 60079-11	
	C22.2 No. 152 applies to %LEL reading for the sensor Part Number 17155304-K only		-20 °C to +50 °C (-4 °F to +122 °F)
IECEX <sup>a</sup>	Class I, Zone 0, Ex ia IIC, equipment protection level Ga, Temperature Class T4	IEC 60079-0:2017	-40 °C to +50 °C (-40 °F to +122 °F)
		IEC 60079-1:2014	

Table 1.1 Hazardous-area certifications

Certifying Body (CB)	Area Classifications	Standards	Approved Temperature Range
	Class I, Zone 1, Ex db ia IIC, equipment protection level Gb, Temperature Class T4, with IR sensor	IEC 60079-11:2011 IEC 60079-26:2021	-20 °C to +50 °C (-4 °F to +122 °F)
INMETRO	Class I, Zone 0, Ex ia IIC, equipment protection level Ga, Temperature Class T4  Class I, Zone 1, Ex db ia IIC, equipment protection level Gb, Temperature Class T4, with IR sensor	ABNT NBR IEC 60079-0 ABNT NBR IEC 60079-11	-40 °C to +50 °C (-40 °F to +122 °F)
MSHA <sup>c</sup>	Permissible for Underground Mines	30 CFR, Part 22	-40 °C to +50 °C (-40 °F to +122 °F)
UKEx	Ex ia I Ma Ex ia IIC T4 Ga  Ex db ia I Ma with IR sensor Ex db ia IIC T4 Gb with IR sensor Equipment Group and Category: I M1, II 1G, and II 2G	EN IEC 60079-0:2018 EN 60079-1:2014 EN 60079-11:2012 EN 50303:2000 EN 60079-26:2015	-40 °C to +50 °C (-40 °F to +122 °F)  -20 °C to +50 °C (-4 °F to +122 °F)
UL	Class I, Division 1, Groups A, B, C, and D, Temperature Class T4  Class II, Division 1, Groups E, F, and G, Temperature Class T4  Class I, Zone 0, AEx ia IIC, Temperature Class T4  Class I, Zone 1, AEx d ia II C, Temperature Class T4, with IR sensor	UL 913 UL 60079-0 UL 60079-1 UL 60079-11	-40 °C to +50 °C (-40 °F to +122 °F)  -20 °C to +50 °C (-4 °F to +122 °F)

<sup>a</sup>Marking requirements are reproduced in Appendix C.

<sup>b</sup>The following apply to instruments that are to be used in compliance with the CSA certification: Ventis Pro4 and Ventis Pro5 instruments are CSA certified according to the Canadian Electrical Code for use in Class I, Division 1 and Class I, Zone 1 Hazardous Locations within an ambient temperature range of T<sub>amb</sub>: -40 °C to +50 °C.

- CSA has assessed only the %LEL combustible gas detection portion of this instrument (the sensor part number 17155304-K only) for performance according to CSA Standard C22.2 No. 152. Within an ambient temperature range of T<sub>amb</sub>: 0 °C to +50 °C, the accuracy is ±3%. Within an ambient temperature range of T<sub>amb</sub>: -20°C up to 0°C, the accuracy is ±5%. This is applicable only when the monitor has been calibrated to 50% LEL CH<sub>4</sub>.

CAUTION: CSA C22.2 No. 152 requires before each day's usage, sensitivity must be tested on a known concentration of pentane or methane equivalent to 25% or 50% of full scale concentration. Accuracy must be within -0% to +20% of actual concentration. Accuracy may be corrected by referring to the zero and calibration section of the Product Manual.

ATTENTION: CSA C22.2 N°152 exige que la sensibilité de l'instrument soit testée avant l'utilisation quotidienne de l'instrument sur une concentration connue de pentane ou de méthane équivalente à 25 % ou 50 % de la concentration totale. L'exactitude doit être entre -0 % et +20 % de la concentration réelle. L'exactitude peut être corrigée en se référant à la partie concernant la mise à zéro et l'étalonnage dans le Manuel du produit.

<sup>c</sup>MSHA requires the monitor be calibrated according to the procedures in the Product Manual only. MSHA also requires the monitor display methane in the percent-by-volume mode (0-5%) for compliance determinations required by 30 CFR Part 75, subpart D.

In addition to the certifications listed below, refer to the Industrial Scientific websites for the most up-to-date information about wireless product [certifications](#).

Table 1.2 Wireless certifications

Agency or authority	Identification number or registration number	Country or region
FCC	PHH-BLEPAN1740, U90-SM200, PHH-VPX Wi-fi battery (if equipped): PHH-WIFICC3220 Cellular battery (if equipped): XPY2AGQN4NNN	USA
IC	216Q-1740, 7084A-SM200, 20727-VPX, M/N Ventis Pro Wi-fi battery (if equipped): 20727-WIFICC3220 Cellular battery (if equipped): 8595A-2AGQN4NNN	Canada

## Warnings and Cautionary Statements

Read and understand this Product Manual before operating or servicing the instrument. Failure to perform certain procedures or note certain conditions—provided below and throughout the manual—may impair the performance of the product, cause unsafe conditions, or both.

Table 1.3 Warnings and cautionary statements





















	Follow local, regional, and country regulations for recycling when an instrument or component (such as sensors or batteries) reaches the End of Life. Do not place it in a landfill.
	If it appears that the instrument is not working correctly, immediately contact Industrial Scientific.
	The instrument must be charged before its first use
	The instrument must not be charged at an ambient temperature of more than +40 °C.
	Be sure to turn off the instrument before (1) servicing the unit or (2) replacing the battery.
	Only qualified personnel should operate, maintain, and service the instrument.
	Substitution of components may impair intrinsic safety, which may cause an unsafe condition. Substituer des composants peut compromettre la sécurité intrinsèque, ce qui peut résulter en une situation dangereuse.
	Do not use in oxygen-enriched atmospheres. If the atmosphere becomes oxygen enriched, it may cause inaccurate readings.
	In an oxygen-enriched environment, there are no additional electrical effects.
	Oxygen-deficient atmospheres may cause inaccurate readings.
	A rapid increase in a gas reading that is followed by a declining or erratic reading may indicate an over-range condition, which may be hazardous.

Table 1.3 Warnings and cautionary statements









---

	Sudden changes in atmospheric pressure may cause temporary fluctuations in gas readings.
	Temperatures below -20 °C (-4 °F) are likely to cause decreased functionality in the instrument's display screen and man-down feature.
	<p>Sudden changes in ambient-air temperature will cause a form of sensor drift in the Carbon Monoxide/Hydrogen Sulfide (CO/H<sub>2</sub>S) sensor (part number 17155306-J) that will produce temporary variations in the sensor's readings:</p> <ul style="list-style-type: none"><li>• If the temperature suddenly <i>increases</i>, the CO reading will temporarily decrease and the H<sub>2</sub>S reading may temporarily increase.</li><li>• If the temperature suddenly <i>decreases</i>, the CO reading will temporarily increase and the H<sub>2</sub>S reading may temporarily decrease.</li></ul> <p>The readings will stabilize when the sensor has acclimated to the change in temperature. For example, if the ambient-air temperatures changes from a "room temperature" of 20 °C (68 °F) to an outdoor temperature of 0 °C (32 °F), the stabilization time is approximately 15 minutes; with smaller or larger changes in temperature, stabilization time will be shorter or longer, respectively.</p> <p><i>Note:</i> If the sensor is to be zeroed after a sudden change in ambient-air temperature, allow the sensor and its readings to stabilize before zeroing.</p>
	<p>The Long-life O<sub>2</sub> sensors (part number 17155304-Y, 17155304-YA and 17155306-Y) are biased sensor, requiring continuous power to operate to specification. Continuous power is provided by a charged battery, regardless if the instrument is powered on. If no power is provided to the sensor, it will experience sensor drift and generate erroneous readings.</p> <p>If an instrument containing a biased sensor experiences a state of no charge, sensor drift will likely occur. If so, Industrial Scientific recommends that the instrument be installed on a compatible charger or docking station. If installed on a docking station, the instrument may fail calibration, but can remain docked to charge. After charging*, undock the instrument; then, redock the instrument or zero it manually. If the instrument does not pass zero, repeat the zero.</p> <p>*If the sensor has been in a no-power state for seven days, it may require a charge period of up to three hours. Charge time will vary based on how long the sensor has been in a no-power state.</p>
	Do <i>not</i> use the Ventis Slide-on Pump (VSP) when testing for target gases susceptible to absorption. Use only the Ventis Pro Pump Module for this purpose. Examples of absorbable gases include but are not limited to Chlorine (Cl <sub>2</sub> ) and Ammonia (NH <sub>3</sub> ). Failure to follow this guideline could result in inaccurate gas readings.
	The Ventis Slide-on Pump is not certified for use according to FTZÚ 18 E 0010 or FTZÚ 18 ATEX 0083 for gas performance.
	To avoid potentially inaccurate readings for some applications—monitoring for gases other than O <sub>2</sub> , CO, CO <sub>2</sub> , H <sub>2</sub> S, and combustible gases [LEL/CH <sub>4</sub> ]— <i>only</i> use a leather case as a carrying case. Do not power on, operate, or power off the instrument while it is in a leather case.
	Silicone and other known contaminants may damage the instrument's combustible gas sensors, which can cause inaccurate gas readings.
	To support accurate readings, keep clean and unobstructed all filters, sensor ports, water barriers, and pump inlet.
	Obstruction of sensor openings—due to dust, dirt, water, or another cause—can inhibit the unit's ability to measure gas concentrations accurately. To support accurate readings, keep sensor openings clean, dry, and properly exposed to the ambient air. The stated ingress protection rating does not imply that the instrument will measure gas while exposed to those conditions.

---

Table 1.3 Warnings and cautionary statements

---

	Obstructed, contaminated, or damaged sensor water barriers (or their gaskets) can inhibit the unit's ability to measure gas concentrations accurately. To support accurate readings, replace the sensor water barriers and gaskets as needed (see "Service" for instructions). The stated ingress protection rating does not imply that the instrument will measure gas while exposed to those conditions.																
	WARNING – When attached to a Ventis Pro, the Standby Clip™ will place man down or selected instrument alarm events on standby. The instrument will NOT alert the operator to hazards associated with these events when the clip is in use.																
	WARNING – Explosion hazard. Only replace batteries in <i>nonhazardous</i> locations.																
	Charge the instrument's battery only in nonhazardous locations. Chargez la batterie de l'instrument uniquement dans des lieux sans danger.																
	Charge the instrument's battery using only compatible accessories from Industrial Scientific, including the chargers listed below.																
	<table border="0" style="width: 100%;"> <thead> <tr> <th style="text-align: left;"><i>Part Number</i></th> <th style="text-align: left;"><i>Description</i></th> </tr> </thead> <tbody> <tr> <td>18109658</td> <td>Ventis Single-Unit Charger</td> </tr> <tr> <td>18108191</td> <td>Ventis Single-Unit Charger</td> </tr> <tr> <td>18108650-A</td> <td>Ventis 6-Unit Charger</td> </tr> <tr> <td>18108209</td> <td>Ventis Single-Unit Charger/Datalink</td> </tr> <tr> <td>18108651</td> <td>Ventis Single-Unit Automotive Charger, 12VDC</td> </tr> <tr> <td>18108652</td> <td>Ventis Single-Unit Truck-Mount Charger, 12VDC, with Cigarette Adapter</td> </tr> <tr> <td>18108653</td> <td>Ventis Single-Unit Truck-Mount Charger, 12VDC, Hard Wired</td> </tr> </tbody> </table>	<i>Part Number</i>	<i>Description</i>	18109658	Ventis Single-Unit Charger	18108191	Ventis Single-Unit Charger	18108650-A	Ventis 6-Unit Charger	18108209	Ventis Single-Unit Charger/Datalink	18108651	Ventis Single-Unit Automotive Charger, 12VDC	18108652	Ventis Single-Unit Truck-Mount Charger, 12VDC, with Cigarette Adapter	18108653	Ventis Single-Unit Truck-Mount Charger, 12VDC, Hard Wired
<i>Part Number</i>	<i>Description</i>																
18109658	Ventis Single-Unit Charger																
18108191	Ventis Single-Unit Charger																
18108650-A	Ventis 6-Unit Charger																
18108209	Ventis Single-Unit Charger/Datalink																
18108651	Ventis Single-Unit Automotive Charger, 12VDC																
18108652	Ventis Single-Unit Truck-Mount Charger, 12VDC, with Cigarette Adapter																
18108653	Ventis Single-Unit Truck-Mount Charger, 12VDC, Hard Wired																
	<p>Perform all instrument service tasks and maintenance procedures in nonhazardous locations only. This includes the removal, replacement, or adjustment of any part on or inside the instrument or its pump.</p> <p>Exécutez toutes les procédures de service les tâches de service sur l'instrument uniquement dans des lieux sans danger. Ceci comprend la dépose d'une pièce positionnée sur l'instrument ou à l'intérieur de celui-ci, ou bien la recharge ou le réglage d'une telle pièce.</p>																
	Battery contacts are exposed on batteries when they are removed from the instrument. Do not touch the battery contacts and do not stack batteries on top of each other.																
	Do not use solvents or cleaning solutions on the instrument or its components.																
	The radios in the Industrial Scientific Ventis Pro 4 and Ventis Pro 5 Portable Multi Gas monitors have been assessed to and found to be below limits as defined in FCC; Innovation, Science and Economic Development Canada; and European Council recommendation 1995/519/EC requirements for human exposure to electromagnetic fields for body and head mounted orientations when used as detailed within this manual.																

---

**Table 1.3 Warnings and cautionary statements**

 This equipment has been tested and found to comply with the limits for a Class B digital device, pursuant to part 15 of the FCC Rules. These limits are designed to provide reasonable protection against harmful interference in a residential installation. This equipment generates, uses and can radiate radio frequency energy and, if not installed and used in accordance with the instructions, may cause harmful interference to radio communications. However, there is no guarantee that interference will not occur in a particular installation. If this equipment does cause harmful interference to radio or television reception, which can be determined by turning the equipment off and on, the user is encouraged to try to correct the interference by one or more of the following measures:

- Reorient or relocate the receiving antenna.
- Increase the separation between the equipment and receiver.
- Connect the equipment into an outlet on a circuit different from that to which the receiver is connected.
- Consult the dealer or an experienced radio/TV technician for help.

Changes or modification made that are not expressly approved by the manufacturer could void the user's authority to operate the equipment.

This device uses electronic labeling to display the FCC and ISED radio certification numbers on the monitor's LCD. They are viewable during the power-on sequence each time the monitor is powered on.

 This device complies with Industry Canada license-exempt RSS standard(s). Operation is subject to the following two conditions: (1) this device may not cause interference, and (2) this device must accept any interference, including interference that may cause undesired operation of the device.

Le présent appareil est conforme aux CNR d'Industrie Canada applicables aux appareils radio exempts de licence. L'exploitation est autorisée aux deux conditions suivantes : (1) l'appareil ne doit pas produire de brouillage, et (2) l'utilisateur de l'appareil doit accepter tout brouillage radioélectrique subi, même si le brouillage est susceptible d'en compromettre le fonctionnement.

 This equipment may not cause interference with duly authorized systems and is not entitled to protection from harmful interference.

 The Ventis Pro 4 and Ventis Pro 5 Portable Multi Gas Monitors contain radio communication modules that generate radio frequency energy. The frequencies and output powers are listed below:

	Radio Frequency	Radio Maximum Transmit Power	
NFC	13.56 MHz	-43.2 dBm (0.000048 mW)	
Bluetooth Low Energy	2402 to 2480 MHz	0 dBm (1 mW)	
LENS® Wireless	2405 to 2480 MHz	3 dBm (2 mW)	
Wi-fi (if equipped with Ventis Pro Wi-fi Battery)	2412 to 2472 MHz	19.1 dBi (81.3 mW) at low Tx duty cycle	
Cellular (if equipped with Ventis Pro Cellular Battery)	TX Bands (Frequency Range)	TX Power	TX Band: Antenna Gain
North American (AT&T and Verizon network versions)	Band 2 (1850 to 1910 MHz)	23 dBm (200 mW) max.	Band 2: -1.8 dBi
	Band 4 (1710 to 1755 MHz)		Band 4: 0.2 dBi
	Band 12 (699 to 716 MHz)		Band 12: -3.0 dBi
	Band 13 (777 to 787 MHz)		Band 13: -2.7 dBi
EU RED version	Band 3 (1710 to 1785 MHz)	23 dBm (200 mW) max.	Band 3: -0.66 dBi
	Band 8 (880 to 915 MHz)		Band 8: -3.9 dBi
	Band 20 (832 to 862 MHz)		Band 20: -2.03 dBi
ANATEL Cellular Version	Band 3 (1710 – 1785 MHz)	23 dBm (200 mW) max.	Band 3: -0.66dBi
	Band 28 (832 – 862 MHz)		Band 28: -6.03 dBi

Table 1.3 Warnings and cautionary statements

	The Ventis Pro 4 and Ventis Pro 5 Portable Multi Gas Monitors contain radio communication modules that generate radio frequency energy. The RF Exposure and SAR (Specific Absorption Rate) information are listed below:
Transmitter exclusion for base Ventis Pro (NFC, BLE, LENS):	<p>For the FCC version, the sum of all transmitters is 3 dBm or 2 mW</p> <p>For the ISED version, the sum of all transmitters is 3 dBm or 2 mW</p> <p>For the EU version, the sum of all transmitters is 3 dBm or 2 mW</p>
SAR for base Ventis Pro (NFC, BLE, LENS) and wi-fi (all transmitters):	<p>The SAR value for FCC version is 0.12 W/kg at 0 mm separation distance.</p> <p>The SAR value for ISED version is 0.12 W/kg at 0 mm separation distance.</p> <p>The SAR value for EU version is 0.016 W/kg at 0 mm separation distance.</p>
SAR for base Ventis Pro (NFC, BLE, LENS) and cellular (all transmitters):	<p>The SAR value for FCC version (Bands 2, 4, 12 &amp; 13) is 0.12 W/kg at 0 mm separation distance.</p> <p>The SAR value for ISED version (Bands 2, 4, 12 &amp; 13) is 0.12 W/kg at 0 mm separation distance.</p> <p>The SAR value for EU version (Bands 3, 8 &amp; 20) is 0.16 W/kg at 0 mm separation distance.</p> <p>The SAR value for ANATEL version (Bands 3 &amp; 28) is 0.16 W/kg at 0 mm separation distance.</p>

The conversion of test and calibration gas concentrations from %LFL to % volume fraction is based on the standard EN 60079-29-1:2022.

Industrial Scientific recommends persons with a pacemaker or implantable cardio defibrillator (ICD) should maintain a minimum separation distance of 15 cm (6 ") between the pacemaker or ICD and a wireless-enabled instrument. Please consult your physician or pacemaker or ICD manufacturer for additional guidance and recommendations.

Do not use in oxygen-enriched atmospheres. Explosion safety is certified only up to 21% Oxygen.

Between regular calibration procedures, Industrial Scientific also recommends that calibration be performed following each of these incidences: the unit falls, is dropped, or experiences another significant impact; is exposed to water; fails a bump test; or has been repeatedly exposed to an over-range (positive or negative) gas concentration. Calibration is also recommended after the installation of a new (or replacement) sensor. The stated ingress protection rating does not imply that the instrument will measure gas while exposed to those conditions.

Only the firmware version **5.00.18** is certified for use according to FTZÚ 18 E 0010 or FTZÚ 18 ATEX 0083 for gas performance. In the event of a firmware change, the applicable measurements according to the certificates will no longer be valid.

**MSHA Conditions of Safe Use**

The diffusion versions of the Ventis Pro 4 and Pro 5 are approved for use with either the rechargeable P/N 17134453-X2, or P/N 17148313-2 (extended) 3.7 volt, lithium-ion batteries only.





The batteries are not user replaceable.

The aspirated version of the Ventis Pro 4 and Pro 5 is approved for use with the P/N 17148313-2 extended battery only.

To be charged on the surface or underground in accordance with 30 CFR 75.340 (the applicable regulations pertaining to battery-charging stations) and MSHA Program Information Bulletin PIB P11-12.

Table 1.3 Warnings and cautionary statements

---

	Charge monitors with an Industrial Scientific Corporation charger designed for use with this monitor.
	Calibrate according to the procedures in the Product Manual, Document No. 17156830-1.
	The monitor must display methane in the percent-by-volume mode (0-5%) for compliance determinations required by 30 CFR Part 75, Subpart D.
	The respective minimum distances that shall be maintained between the Ventis Pro 4 or Pro 5 monitors and any blasting circuits, explosives and detonators for MSHA and the PA Department of Environmental Protection are: MSHA - 6 inches (15.2 cm) PA DEP - 30 inches (76 cm)
	The Ventis Pro with wi-fi and Ventis Pro with cellular have not been assessed by MSHA for underground mining. Using guidance in <i>IME SLP 20 SAFETY GUIDE FOR THE PREVENTION OF RADIO FREQUENCY RADIATION HAZARDS IN THE USE OF COMMERCIAL ELECTRIC DETONATORS (BLASTING CAPS)</i> , a safe distance of 11 feet should be observed for both the Ventis Pro with cellular and Ventis Pro with wi-fi enabled monitors.

---

## Recommended Practices

### Instrument maintenance

The procedures defined below help to maintain instrument functionality and support operator safety.

Industrial Scientific minimum-frequency recommendations for these procedures are summarized below in Table 1.4. These recommendations are provided to help support worker safety and are based on field data, safe work procedures, industry best practices, and regulatory standards. Industrial Scientific is not responsible for determining a company's safety practices or establishing its safety policies, which may be affected by the directives and recommendations of regulatory groups, environmental conditions, operating conditions, instrument use patterns and exposure to gas, and other factors.

### Settings

Settings control how an instrument will operate. They are used to support compliance with company safety policy and applicable regulations, laws, and guidelines as issued by regulatory agencies and government or industry groups.

### Utilities

Maintenance procedures are known as "utilities". Utilities are primarily used to test the instrument or its components for functionality or performance. Each utility is defined below.

#### *Self-test*

The self-test is used to test the functionality of the instrument's memory operations, battery, display screen, and each alarm signal type (audible, visual, and vibration).

#### *Bump Test (or "functional test")*

Bump testing is a functional test in which an instrument's installed sensors are to be briefly exposed to (or "bumped" by) calibration gases in concentrations that are greater than the sensors' low alarm setpoints.

This will cause the instrument to go into low alarm and will indicate which sensors pass or fail this basic test for response to gas. For instructions on how to perform bump test see [Bump testing](#).

### Zero

Zeroing adjusts the sensors' "baseline" readings, which become the points of comparison for subsequent gas readings. It is a prerequisite for calibration. During zeroing, the installed sensors are to be exposed to an air sample from a zero-grade-air cylinder or ambient air that is known to be clean air. If there are gases in the air sample that are below the lowest alarm level, the instrument will read them as zero; its task is to read the air sample as clean air. The user's task is to ensure the air is clean. For instructions on how to perform zeroing see [Zeroing](#).

### Calibration

Regular calibrations promote the accurate measurement of gas concentration values. During calibration, an instrument's installed sensors are to be exposed to their set concentrations of calibration gases. Based on the sensors' responses, the instrument will self-adjust to compensate for declining sensor sensitivity, which naturally occurs as the installed sensors are used or "consumed". For instructions on how to perform calibration see [Calibration](#).

*Note:* During calibration, the span reserve percentage value for each sensor is displayed. An indicator of a sensor's remaining life, when the value is less than 50%, the sensor will no longer pass calibration

### Docking

When docked, instruments that are supported by iNet® Control or DSSAC (Docking Station Software Admin Console) will be maintained for all scheduled bump tests and calibrations, synchronized for any changes to settings, and upgraded for improvements from Industrial Scientific.

### Other Maintenance

The time-weighted average (TWA), short-term exposure limit (STEL), and peak readings can each be "cleared". When any summary reading is cleared, its value is reset to zero and its time-related setting is also reset to zero.

Table 1.4 Recommended frequencies for instrument maintenance

Procedure	Recommended minimum frequency
Settings	Before first use, when an installed sensor is replaced, and as needed.
Calibration <sup>a</sup>	Before first use and monthly thereafter or in accordance with local or national rules, with the maximum interval not exceeding 6 months.
Bump test <sup>b</sup>	Before first use and prior to each day's use thereafter.
Self-test <sup>c</sup>	As needed.

<sup>a</sup>Between regular calibration procedures, Industrial Scientific also recommends that calibration be performed immediately following each of these incidences: the unit falls, is dropped, or experiences another significant impact; is exposed to water; fails a bump test; or has been exposed to an over-range (positive or negative) gas concentration. Calibration is also recommended after the installation of a new (or replacement) sensor. For complete calibration process see [Figure 7.2.B](#).

<sup>b</sup>If conditions do not permit daily bump testing, the procedure may be done less frequently based on instrument use, potential exposure to gas, and environmental conditions as determined by company policy and local regulatory standards.

<sup>c</sup>When redundant sensors are operating on DualSense® technology, bump testing these sensors may be done less frequently based on company safety policy.

<sup>b</sup>A bump test must be performed daily for compliance to EN 45544-1. Workplace atmospheres — Electrical apparatus used for the direct detection and direct concentration measurement of toxic gases and vapors, Part 1: General requirements and test methods, EN 60079-29-1:2016 +A1:2022 +A11:2022 Explosive atmospheres-Gas detectors. Performance requirements of detectors for flammable gases, and EN IEC 62990-1:2022+A11:2022 Workplace atmospheres - Part 1: Gas detectors - Performance requirements of detectors for toxic gases. For complete bump test process see [Figure 7.2.C](#)

<sup>c</sup>The instrument performs a self-test during power on. For an instrument that is set for always-on, the instrument will automatically perform a self-test every 24 hours. The self-test can also be completed on demand by the instrument user.

*Note:* The use of calibration gases not provided by Industrial Scientific may void product warranties and limit potential liability claims.

## First use

To prepare the Ventis Pro Series instrument for first use, qualified personnel should ensure the following are completed:

- Charge the battery at an ambient temperature *below* 40 °C (104 °F).
- Review instrument settings and adjust them as needed.
- Calibrate the instrument.
- Complete a bump test.

## Wearing the instrument

Based on the U.S. Department of Labor's Occupational Safety and Health Administration (OSHA) definition of the breathing zone, it is recommended that the instrument be worn within a 25.4 cm (10") radius of the nose and mouth. Refer to OSHA and to other agencies or groups as needed for additional information.

## Cleaning the instrument exterior

When cleaning the instrument exterior, do not use alcohol, disinfectants, or solvents, or any substance that contains these ingredients as they can damage sensors and otherwise compromise instrument integrity.

For typical dirt and grime, wipe down the instrument with a clean, damp cloth; as needed, use a soap and water solution of 8 to 10 parts water to 1 part dish soap, like Dawn®. To achieve a more serious cleaning, wipe down the instrument with a bleach and water solution of approximately 50 parts water to 1 part bleach as recommended by the US [Centers for Disease Control](#) and Prevention (CDC).

## Remote sampling

**WARNING:** Do *not* use the Ventis Slide-on Pump (VSP) when testing for target gases susceptible to absorption. Use only the Ventis Pro Pump Module for this purpose. Examples of absorbable gases include but are not limited to Chlorine (Cl<sub>2</sub>) and Ammonia (NH<sub>3</sub>). Failure to follow this guideline could result in inaccurate gas readings.

When sampling with a motorized pump and sampling line, Industrial Scientific recommends the following:

- Never operate a pump without an internal filter installed.
- Choose the tubing type based on the target gases. If the target gases are *known*, use Teflon-lined tubing when sampling for these gases: chlorine (Cl<sub>2</sub>), chlorine dioxide (ClO<sub>2</sub>), hydrogen chloride (HCl), and volatile organic compounds (VOCs). For other *known* target gases, urethane tubing or Teflon-lined tubing may be used. When the target gases are *unknown*, use Teflon-lined tubing.
- Know the length of the sample line as it is a factor in determining sampling time. Sample-line length is defined as the distance from the dust filter–water stop opening to the point where the line connects to the pump's inlet. Ensure sample-line length does not exceed the pump's maximum draw.

- A sample line may consist of tubing, a probe, or a probe and tubing.
- During sampling, a pump alarm will occur to indicate insufficient flow. If this occurs, check and correct the tubing cracks or other damage, debris, and proper installation in these areas: the sampling line and its connections, the pump inlet cap and inlet barrel, and the dust filter-water stop items at the end of the sampling line and inside the pump inlet barrel.
- Use a dust filter-water stop (external filter) on the sample line, installed at the line's end, in addition to the internal filter within the pump inlet barrel.
- When replacing pump filters\*:
  - Replace external and internal filters at the same time.
  - Power-off the instrument prior to changing the filters.
  - Inspect the pump inlet cap and barrel; remove any dirt, debris, or liquid by blowing air through the cap or wiping gently with a clean, lint-free cloth.

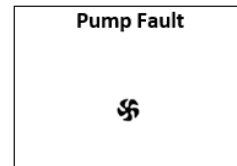

Pump fault alarm

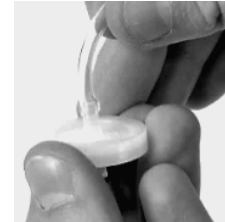

Dust filter-water stop

\*See also

[Pump cap and internal filter replacement.](#)

- Before and after each air sample, perform a test of the full sampling line.
  - Use your thumb to block the end of the sampling line at the water-stop opening. This should cause a pump-fault alarm.
  - Unblock the water-stop opening. After the alarm cycle completes, the pump should resume normal operation.

*Note:* If a pump fault does *not* occur, check and correct for cracks or other damage, debris, and proper installation in these areas: the sampling line and its connections, the pump's inlet cap and inlet barrel, and the dust filter-water stop items at the end of the sampling line and inside the pump inlet barrel.
- In the event that water is pulled into the sampling tubing and pump, clear the tubing and water stop filter (replace if necessary) and then perform a bump test to ensure the system is operating properly.
- Based on sample-line length, calculate the *minimum time* recommended for the air sample to reach the instrument's sensors. As shown below, use a base time of 2 minutes, and add 2 seconds for each 30 cm (1 ') of line length. Watch the display screen for gas readings and, if present, allow them to stabilize to determine the reading.

Table 1.5 Minimum sample time for common sample-line lengths

Sample-line length	Base time	+	Sample-line-length factor	=	Minimum sample time (mm:ss)
3.05 m (10')	2 min	+	(10' x 2 s)	=	02:20
6.10 m (20')	2 min	+	(20' x 2 s)	=	02:40
9.14 m (30')	2 min	+	(30' x 2 s)	=	03:00
12.10 m (40')	2 min	+	(40' x 2 s)	=	03:20
15.24 m (50')	2 min	+	(50' x 2 s)	=	03:40
18.29 m (60')	2 min	+	(60' x 2 s)	=	04:00
21.34 m (70')	2 min	+	(70' x 2 s)	=	04:20
24.38 m (80')	2 min	+	(80' x 2 s)	=	04:40
27.43 m (90')	2 min	+	(90' x 2 s)	=	05:00
30.48 m (100')	2 min	+	(100' x 2 s)	=	05:20

## Cold-weather operation

Use caution when operating the instrument in temperatures below -20 °C (-4 °F), which can diminish display-screen legibility and man-down functionality. To help support functionality and available battery power, the following practices are recommended.

- Do not operate the instrument in temperatures that are not within the temperature ranges of the installed sensors (see "Table 2.7, Sensor specifications").
- Use a compatible, fully charged extended range battery.
- Before using the instrument in the cold-weather environment, power it on in a warm-up environment (approximately 20 °C [68 °F]).
- Alternately operate the instrument in the cold-weather and warm-up environments.
- Do not operate the instrument unmanned.

## Wireless

Ventis Pro instruments and installed Ventis Pro wi-fi and cellular batteries can have wireless operations enabled for a variety of features and functions. During instrument operation, unintended interference can weaken wireless signals. These in-field practices can sometimes enhance signal strength.

- Adjust your position relative to nearby buildings or their walls, floors, and ceilings, and other structures such as a vehicle or machinery.
- GPS is supported by outdoor, open-sky positioning.
- Be as knowledgeable as possible of any dead zones that can interfere with cellular transmission.

Use the range guidelines supplied below to maintain each connection type.

*Note:* The intended wireless performance is supported through docking station operations, which provide regular instrument and wireless-battery firmware updates along with maintenance tasks.

Table 1.6 Range guidelines for wireless connections

Equipment items	Line-of-sight distance, maximum		
	Bluetooth connection	LENS Wireless group connection	Wi-fi battery connection
<b>Instrument to instrument</b>			
Ventis Pro to Ventis Pro	—	100 m (109 yd) <sup>a</sup>	—
Ventis Pro to Radius® BZ1	—	100 m (109 yd) <sup>a</sup>	—
<b>Instrument to gateway</b>			
Ventis Pro to RGX Gateway	—	100 m (109 yd)	—
Ventis Pro to TGX Gateway	—	100 m (109 yd)	—
Ventis Pro to smart-device gateway	30 m (32 yd)	—	—
<b>Other</b>			
Ventis Pro Wi-fi Battery to wi-fi access point	—	—	65 m (71 yd)

<sup>a</sup>Applies when a Ventis Pro instrument is positioned to face the other instrument.



---

## Product Information

Instrument Overview

Personal Protection and Connected Safety

Key Features

Compatibility

Specifications

---

### Instrument Overview

Ventis® Pro portable gas monitors provide personal protection to workers by monitoring for oxygen and a variety of toxic gases and combustible gases. The Ventis Pro5 can monitor up to five gases and has 23 compatible sensors, 14 of which are also compatible with the Ventis Pro4.

LENS® (Linked Equipment Network for Safety) Wireless functionality adds connected safety for Ventis Pro users, enabling the sharing of instrument status (e.g., alarms) among Ventis Pros, Radius BZ1s, and compatible gateways from Industrial Scientific. Gateways and Ventis Pro wireless batteries further enhance connected safety with live monitoring through iNet Now.

The instrument takes gas readings every second and records readings-related data every ten seconds. Data are stored in the instrument data log, which has these characteristics:

- Capacity for approximately three months of readings for a unit that is on 10 hours a day and has four installed, operational sensors.
- Data storage for up to 60 alarms, 30 error events, and 250 manual calibrations and bump tests.
- You can download the log using compatible accessories that are supported by iNet® Control, DSSAC, or Accessory Software from Industrial Scientific.

Ventis Pro Series instruments use a multisensory alarm-warning-indicator system comprising audible, visual, and vibration signals.

The instrument's display-screen language can be set to one of several available language options.

# Personal Protection and Connected Safety

## Personal protection

The Ventis Pro can operate as a gas-detection instrument for the personal protection of individual workers. To achieve this goal, the instrument:

- Alerts the worker to actual and potential gas hazards.
- Activates a man-down alarm when it senses it is no longer being operated by its user.
- Includes a panic button.
- Provides an instructional message option for a variety of specific hazards.

## Connected Safety

### Team safety

As part of a LENS Wireless group, the Ventis Pro can operate as a “peer” equipment item. Peer instruments wirelessly share with one another their gas readings, alarms, and other instrument events. This sharing allows workers and their supervisors to learn of nearby hazardous conditions and team members who may be in distress.

### Live monitoring

iNet Now live monitoring provides an online, virtual view of “in-field” conditions. From a snapshot of gas readings to the occurrence of potentially hazardous events, iNet Now lets safety personnel “see” conditions, supporting their work to marshal responders and resources.

For Ventis Pro instruments, connection to iNet Now is achieved as follows:

- LENS Wireless peer instruments can connect through a gateway.
- A Ventis Pro with a wireless battery has its own direct connection.

The use of gateways and wireless batteries can be combined. For example, a Ventis Pro equipped with a cellular battery can also be part of a LENS group—its user is served by the battery’s direct connection to iNet, and the instrument’s LENS connections to iNet Now and to other workers (peers).

---

## Compatible gateway

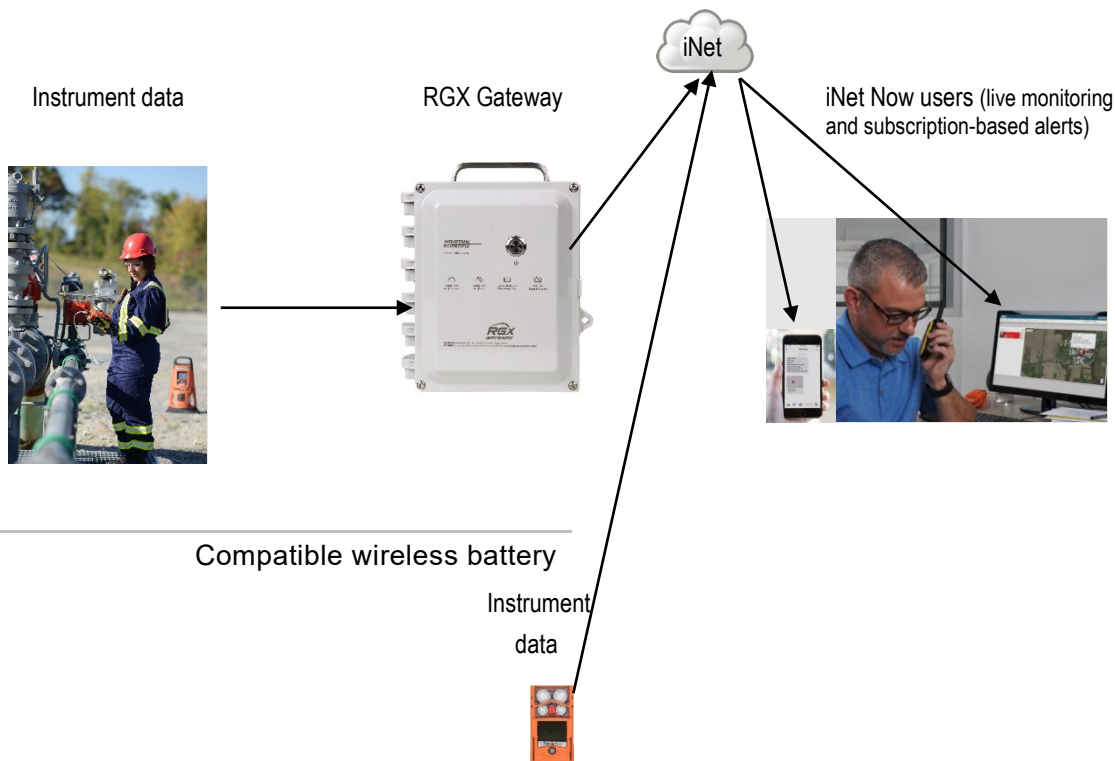

Figure 2.1 Industrial Scientific connected safety

---

## Key Features

### Alarms

#### Gas and other alarms

The instrument will alert the user to the following types of alarm events: gas present, STEL, TWA, man-down, panic, and restricted area proximity using three different signal options and up to four distinct audio patterns. These alarms help ensure worker and team-based safety.

#### Gas alert

This optional feature notifies the instrument operator of the presence of gas in concentrations that may be *approaching* the instrument's alarm setpoints. This alert can prompt workers to check the display screen for gas readings or an instructional message for a specific gas.

#### Latch alarm

This feature keeps an alarm on after the alarm-causing condition no longer exists. This sustains alarm signals, which encourages the worker to check the display screen for gas readings or an instructional message.

## Man-down

The man-down feature allows the instrument to sense when *it* has not moved for a set interval. A man-down alarm may indicate the worker is unable to move or press the panic button, or that the instrument has become separated from its operator.

## Panic button

Pressing the panic button turns on the instrument's high-level alarm. This panic alarm can signal LENS teammates and others who are nearby that the worker or someone else is in distress, or that there is some concern about in-field circumstances.

## Alarm action messages

A unique message (e.g., "EVACUATE") can be set for each installed sensor for these events: gas present (alert, low alarm, and high alarm), STEL, and TWA. You can also set a nonalarm, general message that displays during start-up.

*Note:* Some messages require iNet, DSSAC (Docking Station Software Admin Console), or Accessory Software.

## Connected safety

Powerful wireless communication features—LENS Wireless, wireless batteries, and iNet Now—add connected safety to the personal protection provided by Vents Pro.

## LENS Wireless

Use LENS Wireless peer connections to share instrument status (alarms, readings, etc.) among workers. Add a gateway and share with iNet Now the status of up to 25\* LENS-connected peers per LENS group.

\*The maximum size for each LENS group varies for these specialized applications: 1.) six when a smart-device gateway is in use and 2.) eight when a peer RGX Gateway is used and set to Dynamic Monitoring for plume modeling.

## Wireless batteries

Use a wi-fi or cellular battery to establish a one-to-one, instrument-to-iNet Now connection while staying connected to LENS peer instruments and gateways. The cellular battery also offers the worker preprogrammed text messaging for exchange with preprogrammed cell-phone numbers. Contact Industrial Scientific for information about cellular availability.

## iNet Now

Use iNet Now to virtually “see” the landscape of in-field conditions and the GPS-driven locations of workers in trouble. Set up iNet Now text alerts to be notified of conditions of importance to you.

## Display options

### Full screen alarms

This optional setting displays easy-to-read alarm details in large type and easy-to-identify graphic symbols.

### Gas-information displays

These optional displays provide the worker with setpoints for gas events and calibration gas concentrations. This information can be set to display during start-up, operation, both, or neither.

## Quick-status

This feature allows users to view specific information when the instrument is powered-off: installed sensors, available battery power, and instrument serial number.

## Security and protection

### Always-on

When enabled with a security code, this option prevents the instrument from being powered off during operation.

### Damage resistance

These hardware features help protect the instrument and reduce damage to it:

- Raised ridges shield the sensor ports from dirt and damage when an instrument falls or is dropped.
- The display screen is recessed to protect it from scratches and other damage.
- Rails help reduce wear when the instrument is docked.

## Technologies

### DualSense Technology

DualSense® Technology uses two installed, paired sensors of the same type. The instrument processes both sensors' data but displays only a single gas reading. Data are logged for each paired sensor and the derived DualSense "virtual" one. Each sensor operates independently and will operate as a single sensor if its redundant mate fails. This technology reduces the chance of instrument failure due to sensor failure.

### iAssign Technology

iAssign Technology uses near-field communication (NFC) to communicate with compatible instruments. Applications range from simple to more complex. An *iAssign Tag* simply transfers identifiers (e.g., user name) to an instrument while the *Standby Clip™* and *iAssign Beacon* each affect how the instrument behaves with respect to certain functions and alarms.

## Compatibility

### Sensors and installation locations

Each instrument's compatible sensors can be installed in one or more specific locations as depicted in Figures 2.2.A and 2.2.B for Ventis Pro4 and Ventis Pro5, respectively. Table 2.1 provides the same information but in list format. In addition to the location restrictions for *each* sensor, these installation restrictions also apply:

*Only* install one infrared sensor.

If an infrared sensor is installed in location 1, *do not* install any of these sensors in location 2:

- Hydrogen Sulfide H<sub>2</sub>S (17155304-2)
- Oxygen, O<sub>2</sub> (17155304-3)
- Oxygen, Long-life O<sub>2</sub> (17155304-Y, 17155304-YA)

Do not install the Carbon Monoxide/Hydrogen Sulfide, CO/H<sub>2</sub>S, sensor (17155304-J) when any of these sensors is installed:

- Carbon Dioxide/LEL (Propane) IR (CO<sub>2</sub>/LEL) (17155304-U, 17155304-UA)
- Carbon Dioxide/Methane CO<sub>2</sub>/CH<sub>4</sub> (17155304-V)
- Methane IR, CH<sub>4</sub> (17155304-N)

When a compatible PID sensor is installed, it will require a warm-up period longer than what is needed for most sensors.

- PID sensor warm-up time tends to shorten when the instrument is immediately powered on following docking or charging.
- Once the instrument is powered on, see the instrument display for status information.

For more information about each sensor, including its technology (e.g., infrared), see [Table 2.7 Sensor Specifications](#).

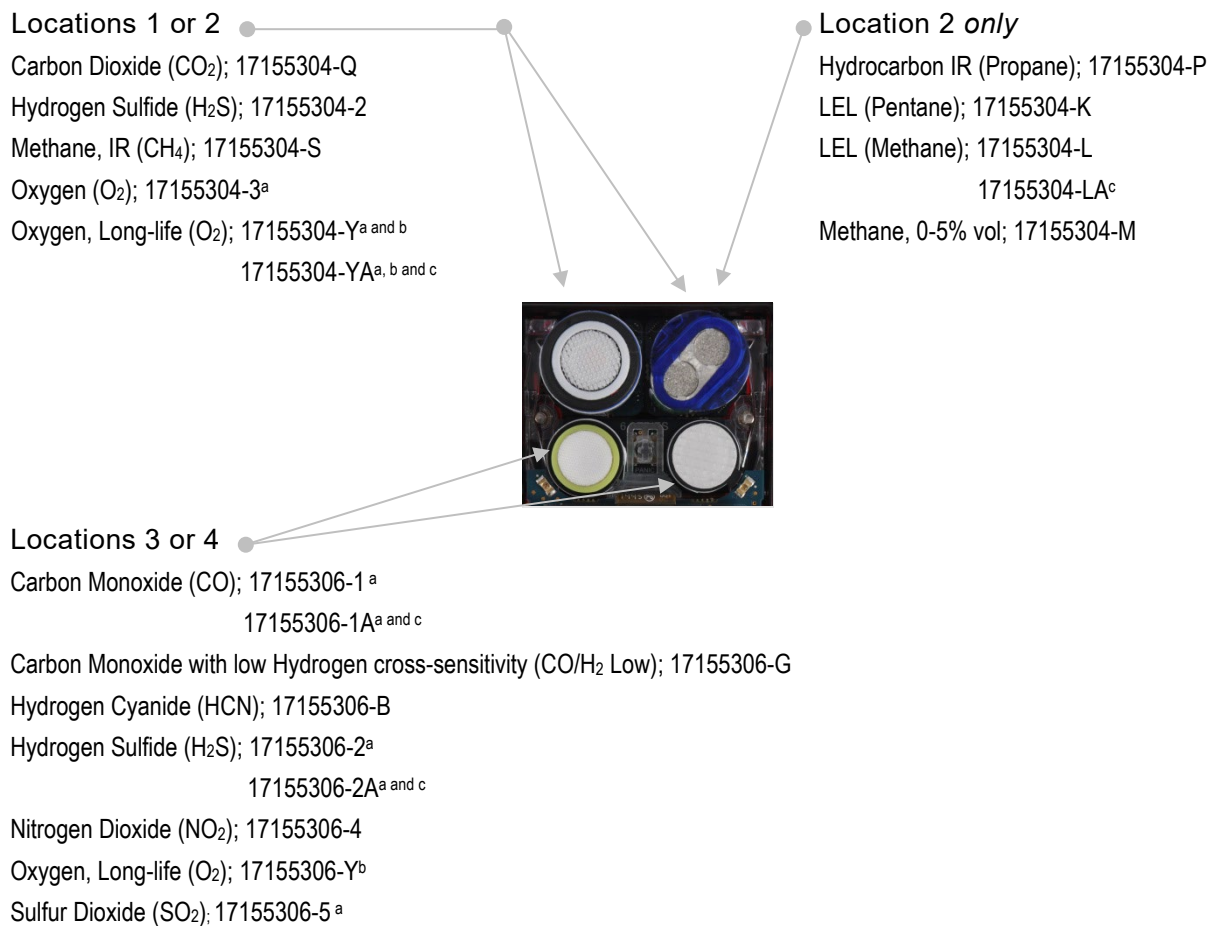

Figure 2.2.A Sensor compatibility and installation locations for the Ventis Pro4

<sup>a</sup>DualSense capable.

<sup>b</sup>Biased sensor.

<sup>c</sup>The sensor is certified for use according to FTZÚ 18 E 0010 or FTZÚ 18 ATEX 0083 or IECEx FTZU 21.001 for gas performance.

---

### Locations 1 or 2

Carbon Dioxide (CO<sub>2</sub>); 17155304-Q  
Carbon Monoxide/Hydrogen Sulfide (CO/H<sub>2</sub>S); 17155304-J  
Hydrocarbon IR (Propane); 17155304-T  
Hydrogen (H<sub>2</sub>); 17155304-C  
Hydrogen Sulfide (H<sub>2</sub>S); 17155304-2  
Methane, IR (CH<sub>4</sub>); 17155304-S  
Oxygen (O<sub>2</sub>); 17155304-3<sup>a</sup>  
Oxygen, Long-life (O<sub>2</sub>); 17155304-Y <sup>a and b</sup>  
17155304-YA <sup>a, b and d</sup>

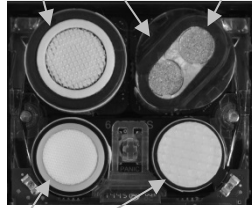

### Location 2 only

Carbon Dioxide/LEL (Propane), IR (CO<sub>2</sub>/LEL); 17155304-U  
17155304-UA<sup>d</sup>  
Carbon Dioxide/Methane (CO<sub>2</sub>/CH<sub>4</sub>); 17155304-V  
Hydrocarbon IR (Propane); 17155304-P  
LEL (Pentane); 17155304-K  
LEL (Methane); 17155304-L  
17155304-LA<sup>d</sup>  
Methane, 0-5% vol; 17155304-M  
Methane IR, (CH<sub>4</sub>); 17155304-N  
Volatile Organic Compounds (VOC); 17155304-R<sup>c</sup>

### Locations 3 or 4

Ammonia (NH<sub>3</sub>); 17155306-6  
Carbon Monoxide (CO); 17155306-1<sup>a</sup>  
17155306-1A<sup>a and d</sup>  
Carbon Monoxide High Range (CO); 17155306-H  
Carbon Monoxide/Hydrogen Sulfide (CO/H<sub>2</sub>S); 17155306-J<sup>a</sup>  
Carbon Monoxide with low Hydrogen cross-sensitivity (CO/H<sub>2</sub> Low); 17155306-G  
Chlorine (Cl<sub>2</sub>); 17155306-7<sup>c</sup>  
Hydrogen Cyanide (HCN); 17155306-B  
Hydrogen Sulfide (H<sub>2</sub>S); 17155306-2<sup>a</sup>  
17155306-2A<sup>a and d</sup>  
Nitrogen Dioxide (NO<sub>2</sub>); 17155306-4  
Oxygen, Long-life (O<sub>2</sub>); 17155306-Y<sup>b</sup>  
Phosphine (PH<sub>3</sub>); 17155306-9  
Sulfur Dioxide (SO<sub>2</sub>); 17155306-5<sup>a</sup>

---

Figure 2.2.B Sensor compatibility and installation locations for the Ventis Pro5

---

<sup>a</sup>DualSense capable.

<sup>b</sup>Biased sensor.

<sup>c</sup>WARNING: Do *not* use the Ventis Slide-on Pump (VSP) when testing for target gases susceptible to absorption. Use only the Ventis Pro Pump Module for this purpose. Examples of absorbable gases include but are not limited to Chlorine (CL<sub>2</sub>) and Ammonia (NH<sub>3</sub>). Failure to follow this guideline could result in inaccurate gas readings.

<sup>d</sup>The sensor is certified for use according to FTZÚ 18 E 0010 or FTZÚ 18 ATEX 0083 or IECEx FTZU 21.001 for gas performance.

Table 2.1 Sensor compatibility and installation locations

	Ventis Pro4	Ventis Pro5	Installation locations	Part number
<i>Sensor</i>				
Ammonia (NH <sub>3</sub> )	No	Yes	3 or 4	17155306-6
Carbon Dioxide (CO <sub>2</sub> )	Yes	Yes	1 or 2	17155304-Q
Carbon Dioxide/LEL (Propane), IR (CO <sub>2</sub> /LEL)	No	Yes	2	17155304-U 17155304-UA <sup>d</sup>
Carbon Dioxide/Methane (CO <sub>2</sub> /CH <sub>4</sub> )	No	Yes	2	17155304-V
Carbon Monoxide (CO) <sup>a</sup>	Yes	Yes	3 or 4	17155306-1 17155306-1A <sup>d</sup>
Carbon Monoxide High Range (CO)	No	Yes	3 or 4	17155306-H
Carbon Monoxide/Hydrogen Sulfide (CO/H <sub>2</sub> S)	No	Yes	1 or 2	17155304-J
Carbon Monoxide/Hydrogen Sulfide (CO/H <sub>2</sub> S) <sup>a</sup>	No	Yes	3 or 4	17155306-J
Carbon Monoxide with low Hydrogen cross-sensitivity (CO/H <sub>2</sub> Low)	Yes	Yes	3 or 4	17155306-G
Chlorine (Cl <sub>2</sub> ) <sup>c</sup>	No	Yes	3 or 4	17155306-7
Hydrogen (H <sub>2</sub> )	No	Yes	1 or 2	17155304-C
Hydrocarbon IR (Propane)	Yes	Yes	2	17155304-P
Hydrocarbon IR (Propane)	No	Yes	1 or 2	17155304-T
Hydrogen Cyanide (HCN)	Yes	Yes	3 or 4	17155306-B
Hydrogen Sulfide (H <sub>2</sub> S)	Yes	Yes	1 or 2	17155304-2
Hydrogen Sulfide (H <sub>2</sub> S) <sup>a</sup>	Yes	Yes	3 or 4	17155306-2 17155306-2A <sup>d</sup>
LEL (Methane)	Yes	Yes	2	17155304-L 17155304-LA <sup>d</sup>
LEL (Pentane)	Yes	Yes	2	17155304-K

Table 2.1 Sensor compatibility and installation locations

	Ventis Pro4	Ventis Pro5	Installation locations	Part number
Methane, IR, (CH <sub>4</sub> )	No	Yes	2	17155304-N
Methane, IR, (CH <sub>4</sub> )	Yes	Yes	1 or 2	17155304-S
Methane, 0-5% vol	Yes	Yes	2	17155304-M
Nitrogen Dioxide (NO <sub>2</sub> )	Yes	Yes	3 or 4	17155306-4
Oxygen (O <sub>2</sub> ) <sup>a</sup>	Yes	Yes	1 or 2	17155304-3
Oxygen, Long-life (O <sub>2</sub> ) <sup>a and b</sup>	Yes	Yes	1 or 2	17155304-Y 17155304-YA <sup>d</sup>
Oxygen, Long-life (O <sub>2</sub> ) <sup>b</sup>	Yes	Yes	3 or 4	17155306-Y
Phosphine (PH <sub>3</sub> )	No	Yes	3 or 4	17155306-9
Sulfur Dioxide (SO <sub>2</sub> ) <sup>a</sup>	Yes	Yes	3 or 4	17155306-5
Volatile Organic Compounds (VOC) <sup>c</sup>	No	Yes	2	17155304-R

<sup>a</sup>DualSense capable.

<sup>b</sup>Biased sensor.

<sup>c</sup>WARNING: Do *not* use the Ventis Slide-on Pump (VSP) when testing for target gases susceptible to absorption. Use only the Ventis Pro Pump Module for this purpose. Examples of absorbable gases include but are not limited to Chlorine (CL<sub>2</sub>) and Ammonia (NH<sub>3</sub>). Failure to follow this guideline could result in inaccurate gas readings.

<sup>d</sup>The sensor is certified for use according to FTZÚ 18 E 0010 or FTZÚ 18 ATEX 0083 for gas performance.

## Batteries

Ventis Pro diffusion instruments are compatible with several rechargeable lithium-ion batteries including those with wireless capabilities. Aspirated instruments are *only* compatible with the extended run-time battery. As indicated below, the label on each battery includes a controlled part number; corresponding *orderable* part numbers are supplied in Table 8.2, Battery parts list.

Table 2.2 Battery compatibility

	Ventis Pro Series	
	Diffusion	Aspirated
Rechargeable Lithium-ion batteries (part number)		
Ventis Pro Wi-fi Battery (17159022-XY <sup>a</sup> )	Yes	No
Ventis Pro Cellular Battery (17159021-XY <sup>a and b</sup> )	Yes (Ventis Pro5 only)	No
Ventis Standard Battery <sup>c</sup> (17134453-XY <sup>a</sup> )	Yes	No
Ventis Slim Extended Battery (17157350-XY <sup>a</sup> )	Yes	No

Table 2.2 Battery compatibility

	Ventis Pro Series	
	Diffusion	Aspirated
Rechargeable Lithium-ion batteries (part number)		
Ventis Extended Run-time Battery (17148313-Y <sup>a</sup> )	Yes	Yes

<sup>a</sup>X indicates color and Y indicates approvals. For more information, see Table 8.2, Battery parts list.

<sup>b</sup>Contact Industrial Scientific about cellular availability.

<sup>c</sup>The Ventis standard battery has been discontinued and is no longer available for ordering. The recommended alternative is the Ventis slim extended battery.

For workers whose instruments will be equipped with wi-fi batteries, use the iAssign app to program iAssign tags with the customer-supplied values listed below. See Appendix B for instructions on [How to program a wi-fi battery-equipped Ventis Pro](#).

- The wi-fi network type, network name, and password.
- The connection type (static or DHCP).
- For a static connection, you will need these values: Network Mask, IP Address, Gateway, and DNS Server.

DO NOT USE THE WI-FI ENABLED BATTERY PACK WITHIN CLOSE LOCATION TO BLAST DETONATOR CIRCUITS. The Wi-fi enabled battery has not been assessed for usage near blasting circuits.

DO NOT USE THE CELLULAR ENABLED BATTERY PACK WITHIN CLOSE LOCATION TO BLAST DETONATOR CIRCUITS. The cellular enabled battery has not been assessed for usage near blasting circuits.

## Gateways

Ventis Pro gas-detection instruments are compatible with Industrial Scientific gateway products as summarized below. Each gateway is suitable for applications noted in its *Product Manual*.

Table 2.3 Ventis Pro Gateway compatibility

Product	Main applications	Product manual part number
RGX Gateway	Hazardous locations as certified; installed or portable	17158071
TGX Gateway	Nonhazardous locations; vehicle installation only	17159042

Note: A smart device running the iNet Now app can also function as a gateway (see the *Start-up Guide*, part number 88100582).

## iAssign accessories

iAssign<sup>®</sup> accessories are compatible with Ventis Pro instruments.

Customer programmable *iAssign Tags* and *Cards* are used to update a Ventis Pro with identifiers such as user name, access level, site name, and network credentials for a wi-fi battery.

*iAssign Beacons* broadcast their customer-programmable access level to in-range Ventis Pro instruments. When the Ventis Pro user-associated access level is lower than that of the Beacon, the instrument will activate its proximity alarm alerting its user they lack access rights to the area.

The *Standby Clip* contains a permanently locked, factory-programmed *iAssign Tag*. When equipped with the Standby Clip accessory, the Ventis Pro will place on standby selected functions including man down and, depending on the instrument's standby setting, gas detection, and peer alarms. When the Standby Clip is removed from an instrument, the affected functions are re-enabled within approximately 5 seconds.

For more information, see the resources listed below and use each accessory in accordance with its noted user document.

Table 2.4 *iAssign* accessories

Item	Properties	Options	User document (part number)
Standard and waterproof tags	Lightweight, adhesive tags that can be attached to a badge or other clean, flat surface. Waterproof tag has a waterproof coating.	User name, user access level, and site name; network credentials for a wi-fi battery	<i>iAssign Start-up Guide</i> (P/N 17159342)
Keychain tag	Suitable for use as a key chain.	User name, user access level, and site name; network credentials for a wi-fi battery	<i>iAssign Start-up Guide</i> (P/N 17159342)
All-weather outdoor tag	A durable plastic tag with a center screw hole; suitable for permanent installation indoors or outdoors.	User name, user access level, and site name; network credentials for a wi-fi battery	<i>iAssign Start-up Guide</i> (P/N 17159342)
<i>iAssign</i> card	Credit-card sized accessory with greater storage capacity that can store up to 868 bytes of data.	Network credentials for a wi-fi battery; user name, user access level, site name, etc.	<i>iAssign Start-up Guide</i> (P/N 17159342)
<i>iAssign Beacon</i>	Suitable for permanent installation indoors or outdoors.	Site and access code; values such as access level and range	<i>iAssign Start-up Guide</i> (P/N 17159342)
Standby Clip	Snaps over the front of the instrument to place on standby man-down and other selected functions.	Not customer programmable; uses a factory-programmed, locked tag	Standby Clip Guide (P/N 17159437)

When using the *iAssign* app to program user and site names, follow the app's on-screen instruction to "write" a tag. When using the app's "write bulk" option, follow the on-screen formatting instructions.

## Other compatibility items

Ventis Pro instruments are compatible with DSX Docking Stations, which are supported by the software applications *iNet* or *DSSAC*.

These accessories can also be used with Ventis Pro instruments: Ventis Charger-Datalink, a variety of Ventis chargers, and the V-Cal calibration stations.

# Specifications

## Instrument

The Ventis Pro Series' instrument specifications are provided below.

Table 2.5 Instrument and pump specifications

Item	Description
Display	Monochrome LCD with automatic backlight
User interface buttons	Three (power button, enter button, and panic button)
Case materials	Polycarbonate with static-dissipative protective rubber overmold
Alarm signals	Visual (two red and two blue lights); audible (95 dB at a distance of 10 cm [3.94 "], typical <sup>a</sup> ); and vibration
Dimensions	104 x 58 x 36 mm (4.09 x 2.28 x 1.42 ")
Weight	200 g (7.05 oz.), typical <sup>b</sup>
Ingress protection <sup>g</sup>	IP68 at 1.5 m (4.9 ') for one hour
Sample flow rate	250 ml/min (15 l/hr)
Upper Limit	415 ml/min (~ 25 l/hr)
Lower Limit	62.5 ml/min (~ 3.75 l/hr)
Calibration flow rate	500 ml/min (30 l/hr)
Pump	With 0.3175 cm (0.125 ") inside diameter sample tubing, sustains a continuous sample draw for up to 30.48 m (100 ').
Air velocity limit (Operation and calibration)	6 m/s
Warm-up time (includes stabilization time)	Up to 100 seconds; up to 10 minutes <sup>f</sup> with installed PID sensor
Maximum power consumption	350 mW
Temperature range <sup>c and d</sup>	
Operation	-40 °C to + 50 °C (-40 °F to + 122 °F)
Storage	-25 °C to + 60 °C (-13 °F to + 140 °F)
Humidity range <sup>d</sup>	15–95% relative humidity (RH) noncondensing for continuous operation and storage
Pressure range	0.8 atm to 1.2 atm (80 kPa to 120 kPa) for continuous operation and storage
Maximum storage time <sup>e</sup>	Up to 12 months at temperature noted above

<sup>a</sup>May vary based on in-field conditions.

<sup>b</sup>May vary based on installed components.

Table 2.5 Instrument and pump specifications

Item	Description
	<sup>c</sup> Temperatures below -20 °C (-4 °F), can diminish display-screen legibility and man-down functionality. See also "Cold-weather Operation" (Chapter 1, "Recommended Practices") and Table 1.1, "Certifications".
	<sup>d</sup> Sensor temperature and humidity ranges may differ from those of the instrument (see "Table 2. 7, Sensor specifications").
	<sup>e</sup> Industrial Scientific recommends infrequently used lithium-ion batteries be fully charged every four months.
	<sup>f</sup> To minimize warm-up time, keep the instrument on a dock (or charger) until use, then once undocked, immediately power on the instrument.
	<sup>g</sup> Refer to <a href="#">Table 1.3 Warnings and Cautionary Statements</a> regarding obstruction of sensor openings and sensor water barriers.

## Battery specifications

Table 2.6 provides battery specifications, which include run time, charge time, and charging temperature requirements. Each battery label includes its controlled part number as indicated below; corresponding *orderable* part numbers are supplied in Table 8.2, Battery parts list.

Table 2.6 Battery specifications

Rechargeable Lithium-ion batteries	Run time	Charge time <sup>c</sup>	Ambient temperature required for charging
Ventis Pro Wi-fi Battery (17159022-XY <sup>d and e</sup> )	14 hours <sup>a</sup>	up to 7.5 hours	0–40 °C (32–104 °F)
Ventis Pro Cellular Battery (17159021-XY <sup>d, e, and f</sup> )	14 hours <sup>a</sup>	up to 8 hours	0–40 °C (32–104 °F)
Ventis Standard Battery <sup>g</sup> (17134453-XY <sup>d</sup> )	12 hours <sup>b</sup>	up to 4 hours	0–40 °C (32–104 °F)
Ventis Slim Extended Battery (17157350-XY <sup>d</sup> )	25 hours <sup>h</sup>	up to 7.5 hours	0–40 °C (32–104 °F)
Ventis Extended Run-time Battery (17148313-Y <sup>d</sup> )	23 hours <sup>b</sup>	up to 7.5 hours	0–40 °C (32–104 °F)

<sup>a</sup>Approximate run time when the following statements are true. The battery is new, fully charged, and its wireless feature is operational. The instrument is operating at room temperature (25 °C [77 °F]) with all alarm signal types enabled and a message interval of 60 seconds. NFC and Bluetooth are enabled. The instrument is in a LENS Group with up to five peer equipment items.

<sup>b</sup>Approximate run time for a diffusion unit when the following statements are true. The battery is new and fully charged. The instrument is operating at room temperature (25 °C [77 °F]) and is in a LENS Group with up to 24 peer equipment items.

<sup>c</sup>When a lithium-ion battery becomes deeply discharged and the instrument is docked, it can take up to an hour for the instrument display to indicate that the battery is charging.

<sup>d</sup>X indicates color and Y indicates approvals.

<sup>e</sup>Not approved for use in MSHA-certified instruments.

<sup>f</sup>Contact Industrial Scientific about availability.

<sup>g</sup>The Ventis standard battery has been discontinued and is no longer available for ordering. The recommended alternative is the Ventis slim extended battery.

<sup>h</sup>Approximate run time for a diffusion unit when the following statements are true. The battery is new and fully charged. The instrument is operating at room temperature (20 °C [68 °F]).

*Note:* Each battery can withstand 300 charge cycles over its lifetime.

## Sensor specifications

Table 2.7 provides specifications for each sensor, which include properties, installation locations, operating conditions, and performance data. For information about restrictions that apply to the instrument's installed-sensor configuration, see Compatibility, [Sensors and installation locations](#) (e.g., only one infrared sensor can be installed). Any sensor property for which there is no available data is indicated by: "—".

If approval-related restrictions apply to a sensor, they are noted in the table's footnotes.

Table 2.7 Sensor specifications

	Gas type (abbreviation)	
	Part number	
	Ammonia (NH <sub>3</sub> ) 17155306-6	Carbon Dioxide (CO <sub>2</sub> ) 17155304-Q <sup>i and k</sup>
<b>Properties</b>		
Category	Toxic	Toxic
Technology	Electrochemical	Infrared
DualSense capable	No	No
<b>Installation location</b>		
Ventis Pro4	None	1 or 2
Ventis Pro5	3 or 4	1 or 2
<b>Operating conditions</b>		
Temperature range <sup>a</sup>	-20 to +40 °C (-4 to +104 °F)	-20 to +50 °C (-4 to +122 °F)
RH range <sup>a</sup>	15-95%	0-95%
<b>Performance</b>		
<i>Sensitivity</i>		
Measurement range	0–500 ppm	0–5% vol
Measurement resolution	1 ppm	0.01% vol
<i>Accuracy<sup>b</sup></i>		
Calibration gas and concentration/Balance gas	50 ppm NH <sub>3</sub> /N <sub>2</sub>	2.5% vol CO <sub>2</sub> /Air
Accuracy at time and temperature of calibration	± 15% (0-100 ppm) 0 to 25% (101–500 ppm)	± 10%
Accuracy over sensor's full temperature range	± 15%	± 10%
<i>Response Time</i>		
T50	30 s	25 s
T90	84 s	60 s

Table 2.7 Sensor specifications

		Gas type (abbreviation) Part number	
		Carbon Dioxide/LEL (Propane), IR (CO <sub>2</sub> /LEL) 17155304-U <sup>c and k</sup> 17155304-UA <sup>c, k and h</sup>	
<b>Properties</b>			
Category		Toxic/Combustible	
Technology		Infrared	
DualSense capable		No	
<b>Installation location</b>			
Ventis Pro4		None	
Ventis Pro5		2	
<b>Operating conditions</b>			
Temperature range <sup>a</sup>		-20 to +50 °C (-4 to +122 °F)	
RH range <sup>a</sup>		15-95%	
<b>Performance</b>	CO <sub>2</sub>	LEL	
<i>Sensitivity</i>			
Measurement range	0-5% vol	0-100% LEL	
Measurement resolution	0.01% vol	1% LEL	
<i>Accuracy<sup>b</sup></i>			
Calibration gas and concentration/Balance gas	2.5% vol CO <sub>2</sub> /Air	25% LEL Propane/Air	
Accuracy at time and temperature of calibration	± 0.1% vol or ±10% of reading, whichever is greater	±5%	
Accuracy over sensor's full temperature range	±10%	±10%	
<i>Response Time</i>			
T50	17 s	18 s	
T90	32 s	38 s	

Table 2.7 Sensor specifications

		Gas type (abbreviation)	
		Part number	
		Carbon Dioxide/Methane (CO <sub>2</sub> /CH <sub>4</sub> )	
		17155304-V <sup>c, k and e</sup>	
<b>Properties</b>			
Category	Toxic and Combustible		
Technology	Infrared		
DualSense capable	No		
<b>Installation location</b>			
Ventis Pro4	None		
Ventis Pro5	2		
<b>Operating conditions</b>			
Temperature range <sup>a</sup>	-20 to +50 °C (-4 to +122 °F)		
RH range <sup>a</sup>	0-95%		
<b>Performance</b>	CO <sub>2</sub>	CH <sub>4</sub>	
<i>Sensitivity</i>			
Measurement range	0-5% vol	0-5% vol	5.1-100% vol
Measurement resolution	0.01% vol	0.01% vol	0.1% vol
<i>Accuracy<sup>b</sup></i>			
Calibration gas and concentration/Balance gas	2.5% vol CO <sub>2</sub> /Air	2.5% vol CH <sub>4</sub> /Air	99% vol CH <sub>4</sub> /N <sub>2</sub>
Accuracy at time and temperature of calibration	± 0.1% vol or ±10% of reading, whichever is greater	± 0.1% vol or ±10% of reading, whichever is greater	± 2% vol or ±10% of reading, whichever is greater
Accuracy over sensor's full temperature range	± 10%	± 10%	—
<i>Response Time</i>			
T50	17 s	15 s	15 s
T90	32 s	30 s	30 s

Table 2.7 Sensor specifications

	Gas type (abbreviation)					
	Part number					
	Carbon Monoxide (CO)		Carbon Monoxide and Hydrogen Sulfide (CO/H <sub>2</sub> S)		Carbon Monoxide and Hydrogen Sulfide (CO/H <sub>2</sub> S)	
	17155306-1 17155306-1A <sup>h and l</sup>	17155306-J		17155304-J		
<b>Properties</b>						
Category	Toxic		Toxic		Toxic	
Technology	Electrochemical		Electrochemical		Electrochemical	
DualSense capable	Yes		Yes		No	
<b>Installation location</b>						
Ventis Pro4	3 or 4		None		None	
Ventis Pro5	3 or 4		3 or 4		1 or 2	
<b>Operating conditions</b>						
Temperature range <sup>a</sup>	-40 to +50 °C (-40 to +122 °F)		-20 to +50 °C (-4 to +122 °F)		-20 to +50 °C (-4 to +122 °F)	
RH range <sup>a</sup>	15-95%		15-95%		15-95%	
<b>Performance</b>						
		CO	H <sub>2</sub> S	CO	H <sub>2</sub> S	
<i>Sensitivity</i>						
Measurement range	0-2000 ppm		0-1500 ppm	0-500 ppm	0-1500 ppm	0-500 ppm
Measurement resolution	1 ppm		1 ppm	0.1 ppm	1 ppm	0.1 ppm
<i>Accuracy<sup>b</sup></i>						
Calibration gas and concentration/Balance gas	100 ppm CO/Air		100 ppm CO/Air	25 ppm H <sub>2</sub> S/N <sub>2</sub>	100 ppm CO/Air	25 ppm H <sub>2</sub> S/N <sub>2</sub>
Accuracy at time and temperature of calibration	± 5%		± 7%	± 10 %	± 5%	0 to 7%
Accuracy over sensor's full temperature range	± 10%		± 5%	± 10%	± 5%	± 10%
<i>Response Time</i>						
T50	12 s		15 s	10 s	15 s	10 s
T90	23 s		35 s	20 s	35 s	20 s

Table 2.7 Sensor specifications

	Gas type (abbreviation)
	Part number
	Carbon Monoxide High Range (CO)
	17155306-H
<b>Properties</b>	
Category	Toxic
Technology	Electrochemical
DualSense capable	No
Installation location	
Ventis Pro4	None
Ventis Pro5	3 or 4
Operating conditions	
Temperature range <sup>a</sup>	-30 to +50 °C (-22 to +122 °F)
RH range <sup>a</sup>	15-90%
Performance	
<i>Sensitivity</i>	
Measurement range	0-9999 ppm
Measurement resolution	1 ppm
<i>Accuracy</i> <sup>b</sup>	
Calibration gas and concentration	100 ppm CO
Accuracy at time and temperature of calibration	± 5%
Accuracy over sensor's full temperature range	-5 to +25%
<i>Response Time</i>	
T50	10 s
T90	21 s

Table 2.7 Sensor specifications

	Gas type (abbreviation)
	Part number
	Carbon Monoxide with low Hydrogen cross-sensitivity (CO/H <sub>2</sub> Low) 17155306-G
<b>Properties</b>	
Category	Toxic
Technology	Electrochemical
DualSense capable	No
<b>Installation location</b>	
Ventis Pro4	3 or 4
Ventis Pro5	3 or 4
<b>Operating conditions</b>	
Temperature range <sup>a</sup>	-20 to +50 °C (-4 to +122 °F)
RH range <sup>a</sup>	15-95%
<b>Performance</b>	
<i>Sensitivity</i>	
Measurement range	0-1000 ppm
Measurement resolution	1 ppm
<i>Accuracy<sup>b</sup></i>	
Calibration gas and concentration/Balance gas	100 ppm CO/Air
Accuracy at time and temperature of calibration	± 5% (0-300 ppm) ± 15% (301-1000 ppm)
Accuracy over sensor's full temperature range	± 15%
<i>Response Time</i>	
T50	8 s
T90	12 s

Table 2.7 Sensor specifications

	Gas type (abbreviation)
	Part number
	Chlorine (Cl <sub>2</sub> )
	17155306-7 <sup>f</sup>
<b>Properties</b>	
Category	Toxic
Technology	Electrochemical
DualSense capable	No
<b>Installation location</b>	
Ventis Pro4	None
Ventis Pro5	3 or 4
<b>Operating conditions</b>	
Temperature range <sup>a</sup>	-20 to +50 °C (-4 to +122 °F)
RH range <sup>a</sup>	15–90%
<b>Performance</b>	
<i>Sensitivity</i>	
Measurement range	0–50 ppm
Measurement resolution	0.1 ppm
<i>Accuracy<sup>b</sup></i>	
Calibration gas and concentration/Balance gas	10 ppm Cl <sub>2</sub> /N <sub>2</sub>
Accuracy at time and temperature of calibration	± 10% of reading or 0.3 ppm, whichever is greater (0–10.0 ppm) ± 20% (10.1–50.0 ppm)
Accuracy over sensor's full temperature range	± 15%
<i>Response Time</i>	
T50	6 s
T90	35 s

Table 2.7 Sensor specifications

	Gas type (abbreviation)
	Part number
	Hydrocarbon, IR (Propane)
	17155304- <sup>Pc and k</sup>
<b>Properties</b>	
Category	Combustible
Technology	Infrared
DualSense capable	No
<b>Installation location</b>	
Ventis Pro4	2
Ventis Pro5	2
<b>Operating conditions</b>	
Temperature range <sup>a</sup>	-20 to +50 °C (-4 to +122 °F)
RH range <sup>a</sup>	0–95%
<b>Performance</b>	
<i>Sensitivity</i>	
Measurement range	0–100% LEL
Measurement resolution	1% LEL
<i>Accuracy<sup>b</sup></i>	
Calibration gas and concentration/Balance gas	25% LEL Propane/Air
Accuracy at time and temperature of calibration	± 5% (0–25% LEL) ± 10% (26–50% LEL) ± 17% (51–100% LEL)
Accuracy over sensor's full temperature range	± 17%
<i>Response Time</i>	
T50	20 s
T90	45 s

Table 2.7 Sensor specifications

	Gas type (abbreviation)
	Part number
	Hydrocarbon, IR (Propane)
	17155304-T <sup>c, k and i</sup>
<b>Properties</b>	
Category	Combustible
Technology	Infrared
DualSense capable	No
<b>Installation location</b>	
Ventis Pro4	None
Ventis Pro5	1 or 2
<b>Operating conditions</b>	
Temperature range <sup>a</sup>	-20 to +50 °C (-4 to +122 °F)
RH range <sup>a</sup>	0–95%
<b>Performance</b>	
<i>Sensitivity</i>	
Measurement range	0–100% LEL
Measurement resolution	1% LEL
<i>Accuracy<sup>b</sup></i>	
Calibration gas and concentration/Balance gas	50% LEL Propane/Air
Accuracy at time and temperature of calibration	±1% LEL or ±10% of reading, whichever is greater
Accuracy over sensor's full temperature range	± 15%
<i>Response Time</i>	
T50	30 s
T90	60 s

Table 2.7 Sensor specifications

	Gas type (abbreviation)
	Part number
	Hydrogen (H <sub>2</sub> )
	17155304-C
<b>Properties</b>	
Category	Toxic
Technology	Electrochemical
DualSense capable	No
<b>Installation location</b>	
Ventis Pro4	None
Ventis Pro5	1 or 2
<b>Operating conditions</b>	
Temperature range <sup>a</sup>	-20 to +50 °C (-4 to +122 °F)
RH range <sup>a</sup>	15–90%
<b>Performance</b>	
<i>Sensitivity</i>	
Measurement range	0–2000 ppm
Measurement resolution	1 ppm
<i>Accuracy<sup>b</sup></i>	
Calibration gas and concentration	100 ppm H <sub>2</sub>
Accuracy at time and temperature of calibration	± 5% (0–100 ppm) ±15% (101–2000 ppm)
Accuracy over sensor's full temperature range	± 20%
<i>Response Time</i>	
T50	39 s
T90	85 s

Table 2.7 Sensor specifications

	Gas type (abbreviation)
	Part number
	Hydrogen Cyanide (HCN)
	17155306-B
<b>Properties</b>	
Category	Toxic
Technology	Electrochemical
DualSense capable	No
<b>Installation location</b>	
Ventis Pro4	3 or 4
Ventis Pro5	3 or 4
<b>Operating conditions</b>	
Temperature range <sup>a</sup>	-30 to +40 °C (-22 to +104 °F)
RH range <sup>a</sup>	15-95%
<b>Performance</b>	
<i>Sensitivity</i>	
Measurement range	0-30 ppm
Measurement resolution	0.1 ppm
<i>Accuracy<sup>b</sup></i>	
Calibration gas and concentration/Balance gas	10 ppm HCN/N <sub>2</sub>
Accuracy at time and temperature of calibration	0 to 10%
Accuracy over sensor's full temperature range	± 15%
<i>Response Time</i>	
T50	18 s
T90	65 s

Table 2.7 Sensor specifications

	Gas type (abbreviation)	
	Part number	
	Hydrogen Sulfide (H <sub>2</sub> S)	Hydrogen Sulfide (H <sub>2</sub> S)
	17155304-2	17155306-2   17155306-2A <sup>h</sup> and <sup>j</sup>
<b>Properties</b>		
Category	Toxic	Toxic
Technology	Electrochemical	Electrochemical
DualSense capable	No	Yes
<b>Installation location</b>		
Ventis Pro4	1 or 2	3 or 4
Ventis Pro5	1 or 2	3 or 4
<b>Operating conditions</b>		
Temperature range <sup>a</sup>	-40 to +50 °C (-40 to +122°F)	-40 to +50 °C (-40 to +122°F)   -20 to +50 °C (-4 to +122°F)
RH range <sup>a</sup>	15-95%	15-95%
<b>Performance</b>		
<i>Sensitivity</i>		
Measurement range	0–500 ppm	0–500 ppm
Measurement resolution	0.1 ppm	0.1 ppm
<i>Accuracy<sup>b</sup></i>		
Calibration gas and concentration/Balance gas	25 ppm H <sub>2</sub> S/N <sub>2</sub>	25 ppm H <sub>2</sub> S/N <sub>2</sub>
Accuracy at time and temperature of calibration	± 5% (0-400 ppm) ± 7% (401-500 ppm)	± 7%
Accuracy over sensor's full temperature range	± 15%	± 15%
<i>Response Time</i>		
T50	10 s	10 s
T90	25 s	25 s

Table 2.7 Sensor specifications

	Gas type (abbreviation)	
	Part number	
	LEL (Methane)	LEL (Pentane)
	17155304-L 17155304-LA <sup>h</sup>	17155304-K
<b>Properties</b>		
Category	Combustible	Combustible
Technology	Catalytic bead	Catalytic bead
DualSense capable	No	No
<b>Installation location</b>		
Ventis Pro4	2	2
Ventis Pro5	2	2
<b>Operating conditions</b>		
Temperature range <sup>a</sup>	-20 to +50 °C (-4 to +122 °F)	-20 to +55 °C (-4 to +131 °F)
RH range <sup>a</sup>	15-95%	15-95%
<b>Performance</b>		
<i>Sensitivity</i>		
Measurement range	0-100% LEL	0-100% LEL
Measurement resolution	1% LEL	1% LEL
<i>Accuracy<sup>b</sup></i>		
Calibration gas and concentration/Balance gas	50% LEL Methane/Air	25% LEL Pentane/Air
Accuracy at time and temperature of calibration	± 3% LEL (0-50% LEL) ± 5% LEL (51-100% LEL)	± 5% LEL
Accuracy over sensor's full temperature range	± 15%	± 15%
<i>Response Time</i>		
T50	8 s	10 s
T90	16 s	16 s

Table 2.7 Sensor specifications

		Gas type (abbreviation)
		Part number
		Methane, IR (CH <sub>4</sub> )
		17155304-S <sup>i, c, e and k</sup>
<b>Properties</b>		
Category		Combustible
Technology		Infrared
DualSense capable		No
<b>Installation location</b>		
Ventis Pro4		1 or 2
Ventis Pro5		1 or 2
<b>Operating conditions</b>		
Temperature range <sup>a</sup>		-20 to +50 °C (-4 to +122 °F)
RH range <sup>a</sup>		0–95%
<b>Performance</b>		
<i>Sensitivity</i>		
Measurement range	0-100% LEL	5.1-100% vol
Measurement resolution	0.1% LEL	0.1% vol
<i>Accuracy<sup>b</sup></i>		
Calibration gas and concentration/Balance gas	50% LEL (2.5 % vol) Methane/Air	99% vol Methane/N <sub>2</sub> <sup>d</sup>
Accuracy at time and temperature of calibration	±2% LEL or ±10% of reading, whichever is greater	± 10%
Accuracy over sensor's full temperature range	± 15%	—
<i>Response Time</i>		
T50	20 s	20 s
T90	45 s	45 s

Table 2.7 Sensor specifications

	Gas type (abbreviation)		
	Part number		
	Methane, IR (CH <sub>4</sub> ) 17155304-N <sup>c</sup> and k		Methane, 0-5% vol 17155304-M
<b>Properties</b>			
Category	Combustible		Combustible
Technology	Infrared		Catalytic bead
DualSense capable	No		No
<b>Installation location</b>			
Ventis Pro4	None		2
Ventis Pro5	2		2
<b>Operating conditions</b>			
Temperature range <sup>a</sup>	-20 to +50 °C (-4 to +122 °F)		-20 to +55 °C (-4 to +131 °F)
RH range <sup>a</sup>	0-95%		15-95%
<b>Performance</b>			
<i>Sensitivity</i>			
Measurement range	0-5% vol	5.1-100% vol	0-5% vol
Measurement resolution	.01% vol	0.1% vol	0.01% vol
<i>Accuracy<sup>b</sup></i>			
Calibration gas and concentration/Balance gas	2.5% vol Methane/Air	99% vol Methane/N <sub>2</sub> <sup>d</sup>	2.5% vol CH <sub>4</sub> /Air
Accuracy at time and temperature of calibration	± 0.1% vol or ±10% of reading, whichever is greater	± 2% vol or ±10% of reading, whichever is greater	± 10%
Accuracy over sensor's full temperature range	± 10%	—	± 15%
<i>Response Time</i>			
T50	15s	15s	7 s
T90	25s	25s	10 s

Table 2.7 Sensor specifications

	Gas type (abbreviation)		
	Part number		
	Nitrogen Dioxide (NO <sub>2</sub> )	Oxygen (O <sub>2</sub> )	Oxygen, Long-life (O <sub>2</sub> )
	17155306-4	17155304-3	17155304-Y 17155304-YA <sup>h</sup>
<b>Properties</b>			
Category	Toxic	Oxygen	Oxygen
Technology	Electrochemical	Electrochemical	Electrochemical
DualSense capable	No	Yes	Yes
<b>Installation location</b>			
Ventis Pro4	3 or 4	1 or 2	1 or 2
Ventis Pro5	3 or 4	1 or 2	1 or 2
<b>Operating conditions</b>			
Temperature range <sup>a</sup>	-20 to +50 °C (-4 to +122 °F)	-20 to +55 °C (-4 to +131 °F)	-20 to +50 °C (-4 to +122 °F)
RH range <sup>a</sup>	15-95%	5-95%	15-90%
<b>Performance</b>			
<i>Sensitivity</i>			
Measurement range	0-150 ppm	0-30% vol	0-30% vol
Measurement resolution	0.1 ppm	0.1% vol	0.1% vol
<i>Accuracy<sup>b</sup></i>			
Calibration gas and concentration/Balance gas	25 ppm NO <sub>2</sub> /N <sub>2</sub>	20.9% vol O <sub>2</sub> /N <sub>2</sub>	20.9% vol O <sub>2</sub> /N <sub>2</sub>
Accuracy at time and temperature of calibration	± 5%	± 0.5% vol	± 0.5% vol
Accuracy over sensor's full temperature range	± 15%	± 0.8% vol	± 0.8% vol
<i>Response Time</i>			
T50	10 s	6 s	10s
T90	20 s	15 s	21s

Table 2.7 Sensor specifications

	Gas type (abbreviation)
	Part number
	Oxygen, Long-life (O <sub>2</sub> )
	17155306-Y <sup>e</sup>
<b>Properties</b>	
Category	Oxygen
Technology	Electrochemical
DualSense capable	No
<b>Installation location</b>	
Ventis Pro4	3 or 4
Ventis Pro5	3 or 4
<b>Operating conditions</b>	
Temperature range <sup>a</sup>	-20 to +50 °C (-4 to +122 °F)
RH range <sup>a</sup>	15–90%
<b>Performance</b>	
<i>Sensitivity</i>	
Measurement range	0–30% vol
Measurement resolution	0.1% vol
<i>Accuracy<sup>b</sup></i>	
Calibration gas and concentration/Balance gas	20.9% vol O <sub>2</sub> /N <sub>2</sub>
Accuracy at time and temperature of calibration	± 0.8% vol (0.0–5.0% vol) ± 0.5% vol (5.1–30.0% vol)
Accuracy over sensor's full temperature range	±0.8% vol
<i>Response Time</i>	
T50	10 s
T90	15 s

Table 2.7 Sensor specifications

	Gas type (abbreviation)	
	Part number	
	Phosphine (PH <sub>3</sub> ) 17155306-9	Sulfur Dioxide (SO <sub>2</sub> ) 17155306-5
<b>Properties</b>		
Category	Toxic	Toxic
Technology	Electrochemical	Electrochemical
DualSense capable	No	Yes
<b>Installation location</b>		
Ventis Pro4	3 or 4	3 or 4
Ventis Pro5	3 or 4	3 or 4
<b>Operating conditions</b>		
Temperature range <sup>a</sup>	-20 to +50 °C (-4 to +122 °F)	-20 to +50 °C (-4 to +122 °F)
RH range <sup>a</sup>	15-90%	15-90%
<b>Performance</b>		
<i>Sensitivity</i>		
Measurement range	0-10 ppm	0-150 ppm
Measurement resolution	0.01 ppm	0.1 ppm
<i>Accuracy<sup>b</sup></i>		
Calibration gas and concentration/Balance gas	1 ppm PH <sub>3</sub> /N <sub>2</sub>	10 ppm SO <sub>2</sub> /Air
Accuracy at time and temperature of calibration	± 5%	± 5% (0-20 ppm) 0 to 11% (21-150 ppm)
Accuracy over sensor's full temperature range	± 15%	± 10%
<i>Response Time</i>		
T50	10s	10 s
T90	20s	25 s

Table 2.7 Sensor specifications

	Gas type (abbreviation)	
	Part number	
	Volatile Organic Compounds (VOC)	
	17155304-R <sup>f</sup> and k	
<b>Properties</b>		
Category	Toxic	
Technology	PID (10.6eV)	
DualSense capable	No	
<b>Installation location</b>		
Ventis Pro4	None	
Ventis Pro5	2	
<b>Operating conditions</b>		
Temperature range <sup>a</sup>	-20 to +50 °C (-4 to +122 °F)	
RH range <sup>a</sup>	0-90%	
<b>Performance</b>		
<i>Sensitivity</i>		
Measurement range	0-2000 ppm	
Measurement resolution	0.1 ppm	
<i>Accuracy<sup>b</sup></i>		
Calibration gas and concentration/Balance gas	100 ppm Isobutylene/Air	5 ppm Benzene/Air
Accuracy at time and temperature of calibration	± 7% (0-2000 ppm)	
Accuracy over sensor's full temperature range	± 15%	
<i>Response Time</i>		
T50	10 s	
T90	16 s	

<sup>a</sup>During continuous operation.

<sup>b</sup>Apply when the instrument is calibrated using the stated calibration gas and concentration; unless otherwise stated, accuracy is equal to the stated percentage or one unit of resolution, whichever is greater.

<sup>c</sup>The following sensors are *not* CSA-assessed for combustible gas detection: part numbers 17155304-N, 17155304-P, 17155304-S, 17155304-T, 17155304-U, 17155304-UA, and 17155304-V; however, these sensors *are* CSA-assessed: 17155304-K, 17155304-L, 17155304-LA and 17155304-M.

<sup>d</sup>Requires manual calibration.

<sup>e</sup>Not approved for use in MSHA-certified instruments.

<sup>f</sup>WARNING: Do *not* use the Ventis Slide-on Pump (VSP) when testing for target gases susceptible to absorption. Use only the Ventis Pro Pump Module for this purpose. Examples of absorbable gases include but are not limited to Chlorine (Cl<sub>2</sub>) and Ammonia (NH<sub>3</sub>). Failure to follow this guideline could result in inaccurate gas readings.

<sup>g</sup>With the integrated pump module or the Ventis Slide-on Pump (VSP), if sensor is placed in slot 1, the T50 increases to 22 seconds.

<sup>h</sup>The sensor is certified for use according to FTZÚ 18 E 0010 or FTZÚ 18 ATEX 0083 or IECEx FTZU 21.001 for gas performance. Measuring range for Oxygen sensor (O<sub>2</sub>) is 0-25%. Measuring range for Carbon Monoxide sensor (CO) is 0-1000 ppm. Measuring range for Methane sensor (CH<sub>4</sub>) is 0-4.4%/vol. Measuring range for Hydrogen Sulfide sensor (H<sub>2</sub>S) is 0-500 ppm. Measuring range for Carbon Dioxide sensor (CO<sub>2</sub>) is 0-5%/vol

<sup>i</sup>The NFC feature is not operational during normal operation when this sensor is installed.

<sup>j</sup>Gas performance testing to FTZÚ 18 E 0010 used 250 ppm H<sub>2</sub>S calibration gas in accordance with EN IEC 62990-1.

<sup>k</sup>This sensor must be zeroed with zero air.

<sup>l</sup>Gas performance testing to FTZÚ 18 E 0010 used 500 ppm CO calibration gas in accordance with EN 45544-1:2015 and EN 45544-3:2015.



---

## Getting Started

Unpacking the Instrument

Hardware Overview

Display Overview

Power On

Power Off

---

### Unpacking the Instrument

Items shipped with the instrument are listed below in Table 3.1; each should be accounted for during the unpacking process. If any item is missing or appears to have been damaged, contact Industrial Scientific (see back cover) or an authorized distributor of Industrial Scientific products.

Table 3.1 Package contents

Quantity	Item	Notes
1 as ordered	Ventis® Pro Series instrument	Ventis Pro4 or Ventis Pro5.
1 as ordered	Battery (factory installed)	One of five available rechargeable lithium-ion batteries.
1	Suspender clip (factory installed)	—
1	<i>Final Inspection &amp; Test Report</i>	Includes information <sup>a</sup> about the instrument and its installed sensors and factory calibration.
1	<i>Quick Start</i>	—
As ordered	Ventis Charger	The universal power cord has four available plugs, one each for use with US, UK, EU, and AUS receptacles.
1	Calibration cup	—
1	Calibration tubing	60.96 cm (2') of urethane tubing; 4.762 mm (3/16") ID.

<sup>a</sup>At the time of shipment.

# Hardware Overview

The instrument's main hardware components are identified below in Figures 3.1.A and 3.1.B for the diffusion and aspirated instruments, respectively (Ventis Pro5 shown).

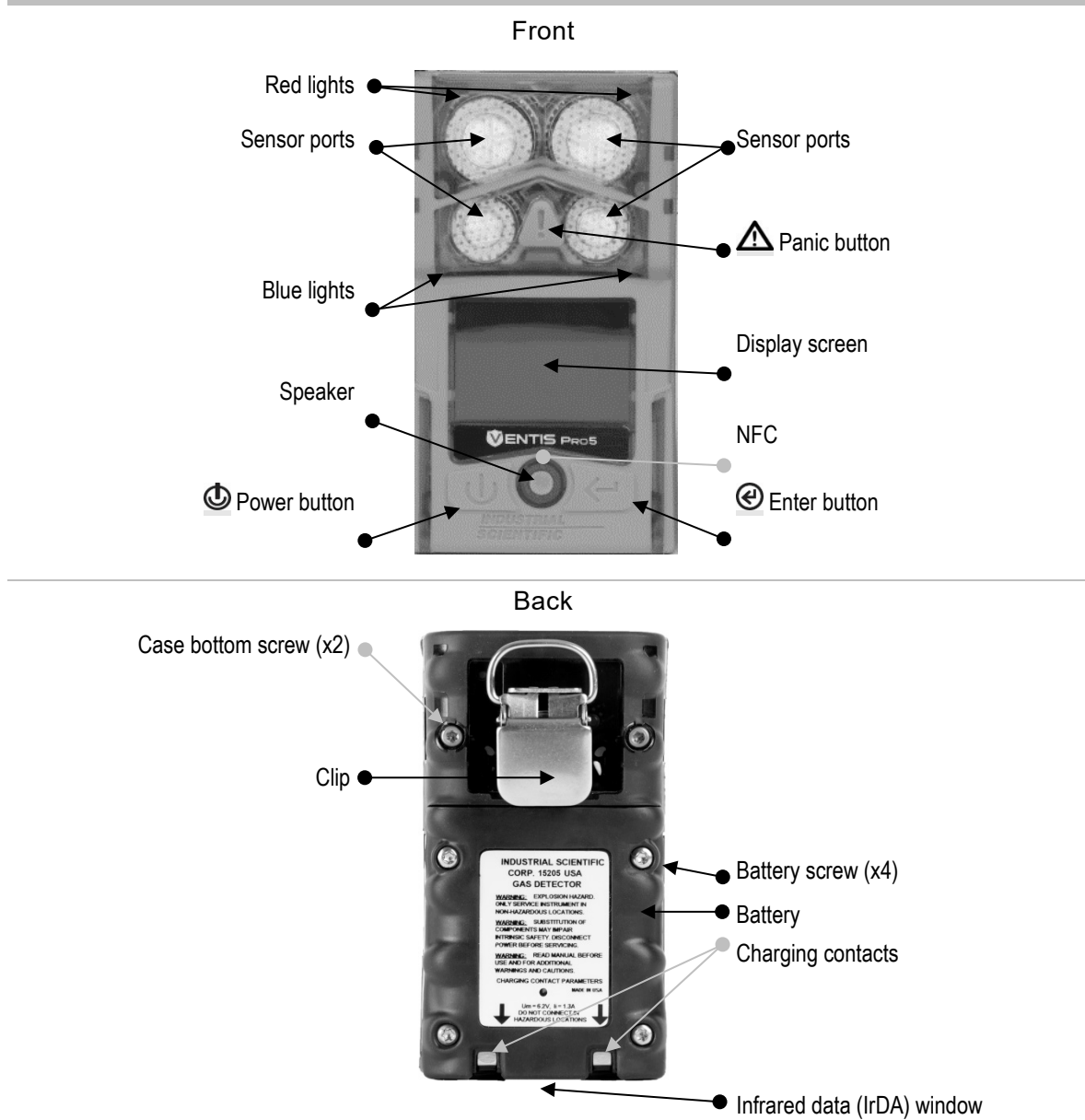

Figure 3.1.A Hardware overview diffusion instrument

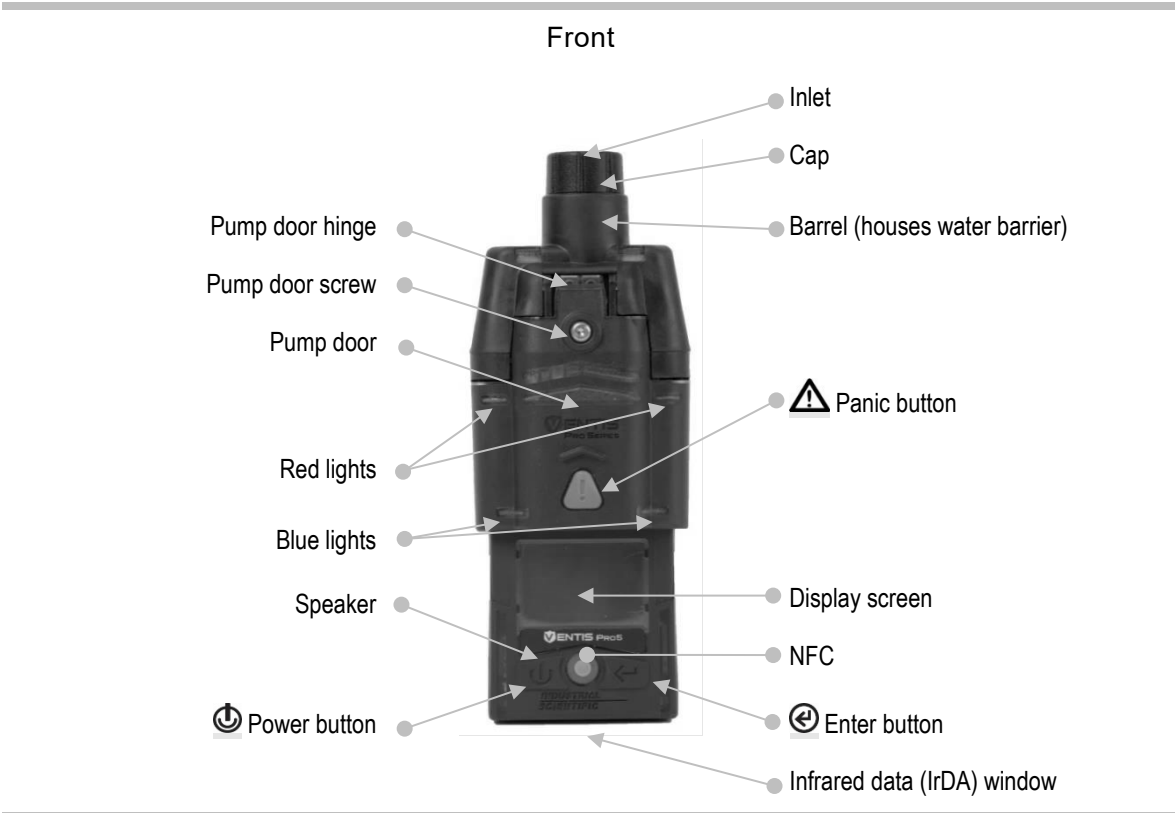

Figure 3.1.B Hardware overview aspirated instrument

# Display Overview

The instrument's easy-to-read display screen has three main horizontal segments. From top to bottom, they are:

- Status bar
- Gas readings area
- Navigation bar

The instrument uses these areas to display symbols, numbers, abbreviations, and text in combinations that allow it to clearly communicate with its user: the instrument operator in the field or team members who are responsible for maintaining the instrument.

See Figures 3.2.A through 3.2.D to become familiar with the display screen layout and content items the user can expect to see at these times:

- During operation
- In the event of a warning or alarm
- During maintenance
- While working in settings

## Status bar

During operation, the display screen's status bar communicates basic information to the instrument operator: instrument and battery status (shown), ambient-air temperature, and the time of day. When the instrument is in a LENS group, the number of equipment items is shown along with the group's signal quality. Cloud and wireless symbols are used to indicate the instrument's wireless connection status.

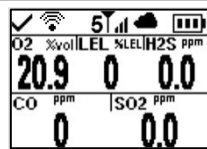

Operation

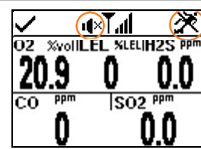





Peer and man-down functions are in standby status (symbols circled) and are not operational; the Standby Clip is attached.

### Instrument status symbol

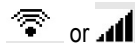
 Indicates the instrument is operational.

### Battery wireless status

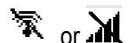
 or  A wi-fi or cellular battery is installed and connected to a network (strongest signal quality shown here with three bars).

 or  A wi-fi or cellular battery is installed, but its wireless and GPS features are not operational or wireless connection lost.

no wireless symbols A wi-fi or cellular battery is installed, but its communications setting option is set to off.

 Access an incoming text message or create a message.

### LENS Wireless status

5 and  Indicates the LENS Wireless group peer count and the group's signal quality (strongest signal quality shown with four bars).



 LENS Wireless is not operational.

0 and  LENS Wireless connection lost; no peers.

no LENS symbols      LENS Wireless is set to "off" and LENS Wireless features are not available

**iNet Now status**

no cloud      The instrument's firmware, settings, or LENS Wireless status make it *unavailable* for live monitoring by users of iNet Now.

 or       The instrument is wirelessly connected to iNet; it is available for live monitoring by users of iNet Now.

      Wireless connection(s) lost. The instrument is *not* wirelessly connected to iNet; it is unavailable for live monitoring by users of iNet Now.

      The instrument is wirelessly connected to iNet via a smart-device gateway; while it is available for live monitoring by users of iNet Now, the instrument-to-smart device wireless connection is weak.

**Other symbols**

      The instrument's man-down feature is not operational.

      Peer alarms are in standby status and are not operational.

Name      User name assigned to peer instrument readings.

      Pump installed.

      The battery's level of charge is between 67 and 100%.

      The battery's level of charge is between 34 and 66%.

      The battery's level of charge is less than or equal to 33%.

      The battery's level of charge is approaching a critically low level.

11:34a      The time of day (12-hour format shown).

76 F      The ambient-air temperature reading (Fahrenheit shown).

Gas readings area →

In addition to the display of current gas readings, this area communicates status information about the installed sensors.

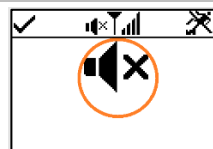
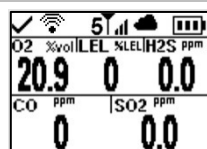

Gas readings

Gas detection (symbol circled), peer alarms, and man down are in standby status and are not operational; the Standby Clip is attached.

---

Gas reading

O<sub>2</sub> %vol  
**20.9**

Gas, unit of measure, and current reading.



The instrument's gas detection is in standby status and is not operational.

Other symbols

**F**

The indicated sensor is in a general state of failure.

**ØF**

The indicated sensor failed zeroing.

**CAL**

The indicated sensor failed calibration.

**BUMP**

The indicated sensor failed bump testing.

**ERR**

The indicated sensor is installed in the wrong location.



**Ø**

The CO<sub>2</sub> or O<sub>2</sub> sensor is installed in the wrong location.

---

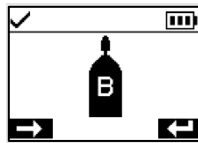
Navigation Bar



During operation, there may be maintenance utilities or other options available to the instrument operator. If so, the bottom area of the display screen will feature the *navigation bar*. The action displayed on the left is controlled by the button underneath it, the power button ; the action on the right is controlled by the enter button .

Instructional symbols and text



Start the option (bump test utility shown above).



Skip the option and go to the next display screen.

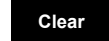

Clear values.



Access an incoming text message or create a message.



Send a text message.



Cancel a text message.

Figure 3.2.A Reading the display during operation

---

Status bar

Gas readings area

In the event of an instrument warning or alarm, the gas readings area communicates the event type, details about the alarm, and gas readings for all sensors.

Peer events use symbols that are similar to instrument-event symbols. When shown in the status bar, they are generally white on a black background.

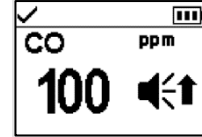
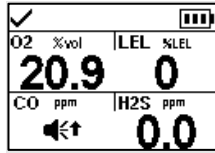

Full-screen alarm format

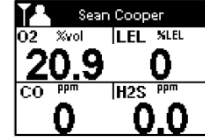

Peer alarm

#### Event symbols (gas-related)

- and **OR** Gas present, over-range alarm
- and **-OR** or and **UR** Under-range or negative over-range gas alarm.

- and Gas present, high-alarm

- and Gas present, low-alarm

- Gas present, alert (warning)

- STEL** Short-term exposure limit (STEL) alarm

- TWA** Time-weighted average (TWA) alarm

- Alarm is latched

#### Other symbols (nongas-related, full-screen symbol)

- Critical low battery
- Indicates the in-alarm instrument is a Ventis Pro Series monitor.
- Indicates the in-alarm peer instrument is a Radius BZ1 Area Monitor.
- Panic Alarm** ; Panic alarm; peer panic alarm
- MAN DOWN** ; Man-down alarm; peer man-down alarm
- Peer Name** A peer equipment item has lost its wireless connection to the LENS group.
- Group Lost** The instrument is no longer wirelessly connected to any LENS group equipment item.
- No Peers** All equipment items have left the group.
- ERROR 408** System error (408 shown)

See [Appendix E](#) for detailed audio and visual pattern.

Figure 3.2.B Reading the display during an event (warning or alarm)

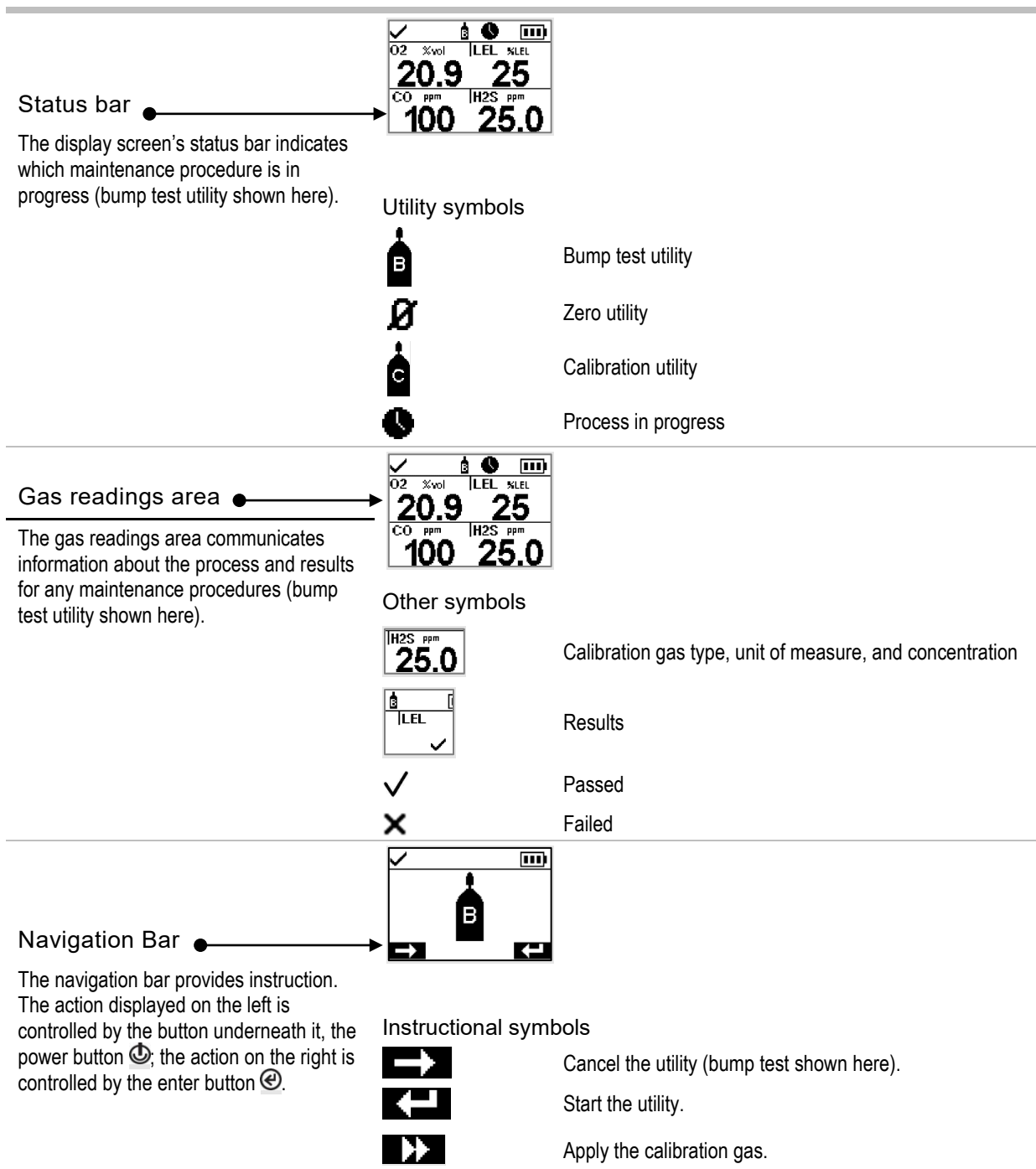
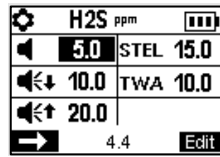

Figure 3.2.C Reading the display during maintenance

**Status bar**

When working in settings, the status bar may indicate the setting name (H<sub>2</sub>S settings shown here).



Multi-item setting

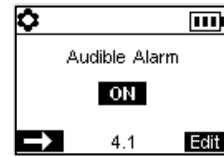



Single-item setting

**Editing area**

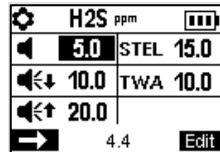
The editing area displays the settings' values. The highlight bar indicates which setting is being edited (gas-alert value shown here).



**Navigation bar**

The navigation bar provides instruction for navigating settings. The action displayed on the left is controlled by the button underneath it, the power button ; the action on the right is controlled by the enter button .

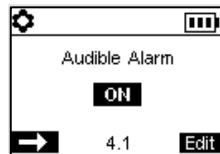

**Status bar symbol**



Settings.

**Other symbols**



Current setting.



Go to the next setting.



Edit the setting.



Edit the setting.



Scroll an options list.



Exit.

X.Y

"X" indicates the display screen's menu number; "Y" indicates its setting number.

Figure 3.2.D Reading the display while working in settings

In addition to the items described above, the Ventis Pro Series' display will also feature, when relevant, the gas names, units of measure, and other symbols shown below.

**Gas names**















- CH<sub>4</sub> CH<sub>4</sub> (Methane)
- CO Carbon Monoxide
- CO<sub>2</sub> CO<sub>2</sub> (Carbon Dioxide)

H2S	H <sub>2</sub> S (Hydrogen Sulfide)
HCN	Hydrogen Cyanide
LEL	Combustible gases
NH3	NH <sub>3</sub> (Ammonia)
NO2	NO <sub>2</sub> (Nitrogen Dioxide)
O2	O <sub>2</sub> (Oxygen)
SO2	SO <sub>2</sub> (Sulfur dioxide)

### Units of measure

ppm	Parts per million.
mg/m <sub>3</sub>	Milligrams per cubic meter.
% LEL	The lower explosive limit (LEL) is the minimum concentration of a gas, which, if given an ignition source, is capable of producing a flash of fire.
% vol	Percent by volume refers to a defined amount of the gas in 100 parts of air. For example, normal air contains 21% vol oxygen, or 21 parts oxygen in every 100 parts of air.

### Other symbols

	This symbol indicates specific functions are in standby status and are not operational; gas detection when the symbol is displayed in gas readings area, peer events when in status bar.
	Present when GPS coordinates are being received via satellite; otherwise, the coordinates indicate the last-received GPS location.
	Yes.
	No.
	Maintenance due (calibration shown).
	The down arrow indicates the number of <i>days since</i> the maintenance procedure was last completed. The up arrow indicates the number of <i>days until</i> the maintenance procedure is next due.
	Peak readings.
	Used with peer messages to indicate the peer instrument is a Radius BZ1.
	Used to identify an instrument's assigned (or available) user name. Also used with peer messages to indicate the peer instrument is a Ventis Pro Series instrument.
	Used to identify an instrument's assigned site name.
	Return the instrument to Industrial Scientific.
	Security code is required.
	Data exchange or synchronization may be in progress.
	Indicates that the sensor is operating on DualSense technology.



A sensor that was operating on DualSense has failed.



A sensor operating on DualSense is due for maintenance (sensor 1 shown here).

## Power On

If a pump is installed, complete the following pump preparation steps before powering on the instrument.

If the use of the integrated pump is desired, but has not been installed, see Figure 8.3 Service Tasks for pump installation instruction.

---



Attach one end of the sample tubing to the pump inlet's nipple (left); attach the other end to a compatible water stop (right).

At each end, push on the tubing to ensure the connecting part is fully inserted into the tubing (approximately .635 cm [.25"]). To test for a firm connection, gently pull on the tubing.

---

To power on the instrument, press and hold the power button  for approximately three seconds, until the blue lights flash. The instrument will perform a *self-test*; its operator should observe the instrument and its display screen to verify the unit is operating as expected (see Figure 3.3 below).

Immediately following the self-test is the *start-up sequence*, which will provide information and may prompt the worker to prepare the instrument for use. Preparation and utility options included in the start-up sequence may vary from those shown below depending on instrument settings and functionality.

At the end of the power-on process, the home screen will display.

## Self-test

### Light test

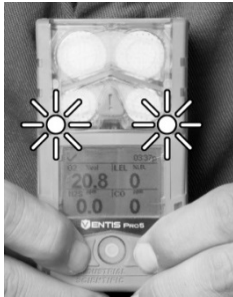

The blue lights will flash followed by the red lights. Verify that all lights are functional.

### Display test

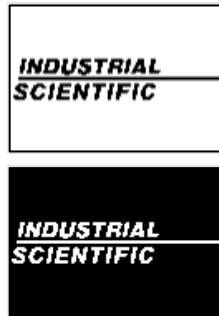

Observe the display screen to verify that all pixels are functional.

### Audible and vibration test

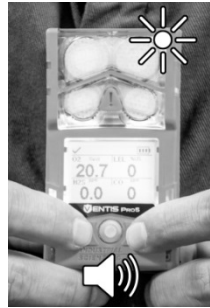

The instrument will vibrate and then emit a loud beep. Verify that both signal types are functional.

### Sample error message

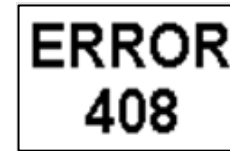

If the instrument fails any part of its self-test, an error message will display. If the instrument or its operator detect problems, contact Industrial Scientific for assistance.

## Start-up sequence

### Information

#### Date and time

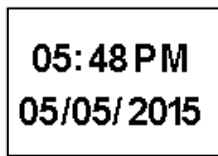

If the battery has been reinstalled or replaced, the instrument operator may be prompted to set the date and time, which can be done manually or by docking the instrument.

#### Tap iAssign tag



Tap the instrument to the desired iAssign tag. If no tag is used within 30 seconds, startup will continue.

#### Instrument information



—

#### Wireless information

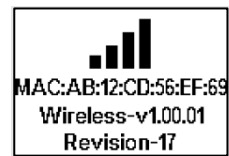

—

#### Regulatory information

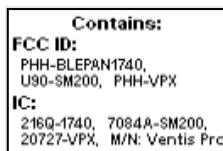

—

#### Update network credentials (wi-fi battery only)



To change network credentials for the installed wi-fi battery, tap the instrument to the desired iAssign tag. If no tag is used

#### Instrument assignments

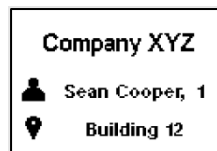

—

Indicates the company, person (user), and location (site) to which the instrument is currently assigned.

*Note:* When a ", X" displays next to the user name, it indicates the access level for the instrument's current user, which applies to Beacon-restricted areas.

within 30 seconds, startup will continue.

Maintenance information



The dock information (above left) indicates maintenance is due in the future ("days until").

The calibration information (above right) indicates when the maintenance was last performed ("days since"). Calibration information can also appear as due in the future.

Gas information

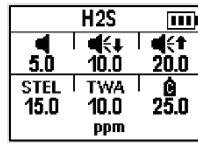

A series of information screens provide the setpoints for each sensor (H<sub>2</sub>S shown). The values from left to right are:

Top row: gas present alert, low alarm, and high alarm. Bottom row: STEL alarm, TWA alarm, and calibration gas concentration. Verify that the settings are appropriate.

Preparation and utilities

Start-up message



Read and understand the message.



Acknowledge message.

Compliance check  
(German-language instruments only)



Answer "no".

Answer "yes".



If a pump has been installed, the instrument will prompt its operator to complete the following pump test.

Pump test

Block inlet

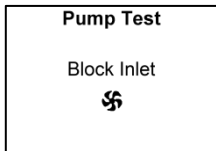

When prompted, use your thumb to block the end of the sampling line, the water-stop opening.

Wait

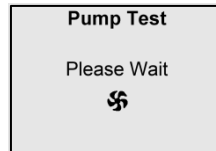

While the test is in progress, the display screen will ask the instrument operator to wait. Next, the test results will be displayed as "Passed" or "Failed".

Test results: Passed

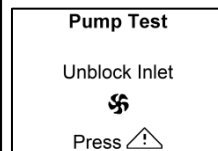
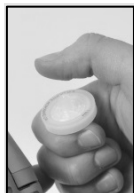
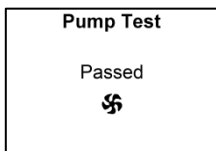

Restart the pump: Press

Test results: Failed\*

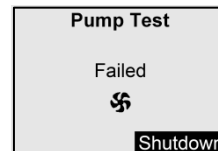



Unblock the water-stop opening.

It may take several seconds for the pump to restart.

Unblock the water-stop opening.

Power off the instrument.

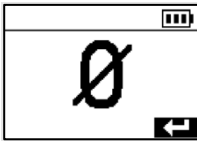
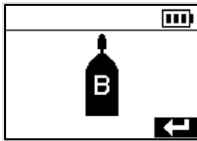
\*Note: A failed pump test may indicate a problem somewhere in the sampling line. Check and correct for cracks or other damage, debris, and improper installation in these areas: all sampling line connections and the pump's inlet cap, inlet barrel, and dust filter.

Zero utility	Bump test utility	—
		—
<p>Skip the utility: wait 15 seconds.</p> <p> Start the utility.</p>	<p>Skip the utility: wait 15 seconds.</p> <p> Start the utility.</p>	—

### Home

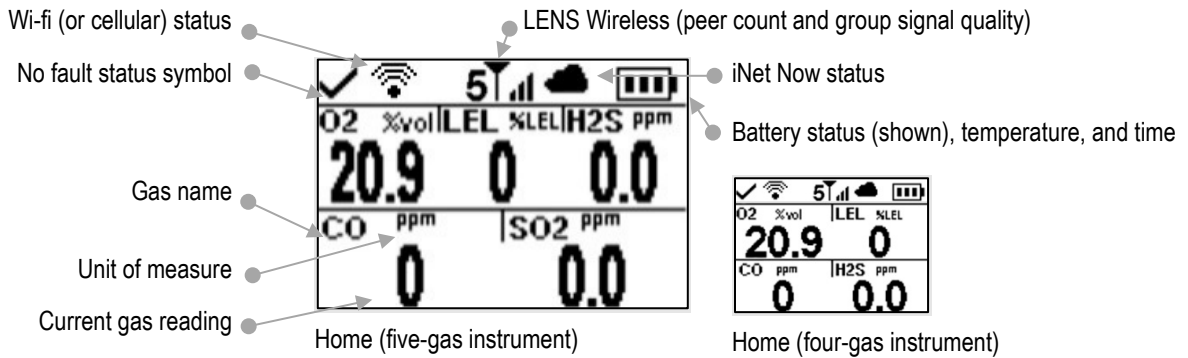

Wi-fi (or cellular) status  
 No fault status symbol  
 Gas name  
 Unit of measure  
 Current gas reading  
 LENS Wireless (peer count and group signal quality)  
 iNet Now status  
 Battery status (shown), temperature, and time

Home (five-gas instrument)

O2 %vol	LEL %LEL	H2S ppm
20.9	0	0.0
CO ppm	SO2 ppm	
0	0.0	

Home (four-gas instrument)

O2 %vol	LEL %LEL
20.9	0
CO ppm	H2S ppm
0	0.0

Figure 3.3 Power on

## Power Off

If the instrument is set to remain on, power off may require the entry of the unit's security code.







Home	Countdown	Enter security code
		
		 
Start power-off countdown.	Hold for the full five-second countdown.	Enter the displayed value. Edit the displayed value.

Figure 3.4 Power off

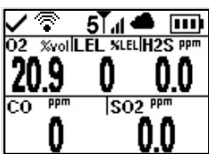
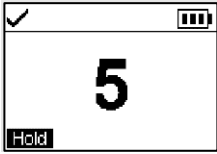
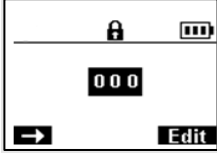
### *Quick-status information*

When the instrument is powered off, the installed sensors, available battery power, and instrument serial number can be viewed without powering on the instrument: simultaneously press and hold  and  for two seconds.



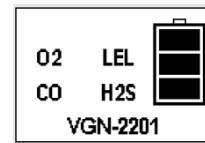

---

# Settings

Guidelines

Accessing Settings

Settings Menus

Connected Safety Settings

Examples for Working in Settings

Reviewing and Editing Settings



---

## Guidelines

Settings that can be adjusted manually through the instrument are described in this Product Manual. These and other settings can also be adjusted through compatible Industrial Scientific docking stations and accessories supported by iNet Control, DSSAC, and Accessory Software; *any changes made manually to the instrument will be overridden when the instrument is docked.*

Only qualified personnel should access and adjust instrument settings; this person is referred to below as the "safety specialist". To help guard against unintended access by nonqualified personnel, settings can be security-code protected.

## Accessing Settings

Settings can be accessed while the instrument is powering on—during the start-up sequence—by simultaneously pressing then releasing  and . If the security-code screen is activated, settings are protected and the instrument's security code must be entered. If the entered value matches the instrument's security code, the first settings menu (1.0 Maintenance) will display; otherwise, access to settings will be denied and the instrument will resume start-up.

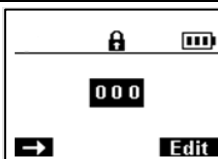

Press   
Enter the  
displayed  
value.

Press   
Edit the  
value.

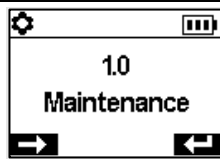

Press   
Next menu

Press   
Start  
maintenance

## Settings Menu

A menu system is used to organize instrument settings by topic. This allows the safety specialist to first choose the menu (topic) of interest, such as alarms, then review and optionally "edit" (adjust) each available setting within that menu. The table below summarizes the settings that are available in each menu. Later in the chapter, the available options for each setting—by menu—provide additional information that will help you choose the appropriate settings for your applications.

Table 4.1 Settings menus

Menu number and topic	Settings summary
1.0 Maintenance	A primary purpose of the maintenance menu is to provide the safety specialist with access to maintenance procedures (utilities). Menu options also include NFC and Bluetooth settings, which are needed for an instrument that will use iAssign <sup>®</sup> accessories or will send instrument data to the iNet Now Sync App, respectively.
2.0 Start-up	These settings allow the safety specialist to permit or prohibit all-user access, from the startup sequence, to various functions and assignments. Access is set separately for each item.
3.0 Operation	The operation menu allows the safety specialist to permit or prohibit—during instrument operation—all-user access to utilities and maintenance status information. Access is set separately for each item. From here, the specialist can also permit or prohibit the use of iAssign tags during instrument operation.
4.0 Alarm	Alarm settings allow the safety specialist to set the values for each gas event that will cause the instrument to alarm.  The specialist can also permit or prohibit instrument power off during alarms and make other choices about alarm- and warning-related instrument behavior.
5.0 Sensor	Sensor settings allow the safety specialist to view basic information about the installed sensors and control settings related to calibration and bump test utilities.
6.0 Admin (Administration)	Admin settings allow the safety specialist to control important aspects about how the instrument communicates with its operator. For example, a security code can be set to help restrict all-user access to settings.  The safety specialist can also set the display-screen language, maintenance-related warnings, and other items.
7.0 Wireless	Wireless settings allow the safety specialist to turn on or off LENS Wireless and to choose settings for LENS' group-related warnings and data encryption. The wireless communication feature for a wi-fi or cellular battery can be set on or off; if on, its to-iNet, noncritical message interval can also be set.

## Connected Safety Settings

The table below summarizes the required settings for connected safety when using a Ventis Pro with LENS Wireless and a compatible gateway. While the Wireless menu contains most of these settings, other settings, Ventis Pro firmware requirements, and gateway product-manual part numbers are also noted below.

Table 4.2 Ventis Pro—gateway firmware and settings requirements

	Gateway (user document part number)		
	RGX Gateway (Product Manual 17158071)	TGX Gateway (Product Manual 17159042)	Smart-device gateway (Startup Guide 88100582)
<b>Instrument requirements</b>			
Ventis Pro firmware version	V4.1 or higher	V4.1 or higher	V2.3 or higher
<b>Ventis Pro settings</b>			
<b>Wireless menu</b>			
LENS Wireless	iNet Now and Local	iNet Now and Local	Optional
LENS Wireless, LENS Group	Group X or Scan	Group X or Scan	Optional
Encryption (recommended)	Default or custom	Default or custom	Default or custom
<b>Maintenance menu</b>			
Bluetooth	Not required	Not required	iNet Now or iNet Now and Local
NFC (near-field communication)	On	Not required	Not required

## Examples for Working in Settings

Two examples are provided below to illustrate how to navigate in and adjust settings.

Each example includes a goal, a target setting that is to be changed; the navigation path that leads to the target setting; and instruction to change the target setting.

Example 1 features a single-item setting—a setting that has a value of “on” or “off”.

Example 2 features a multi-item setting where the value for each of several items can be changed—one item at a time.

### *Example 1. Editing a single-item setting*

Goal: Latch the instrument's alarms

- From the 1.0 Maintenance menu, navigation leads to the 4.0 Alarm menu where the alarm-latch setting resides. Along the way, the navigation bypasses menus 1.0, 2.0, and 3.0.
- From the 4.0 Alarm menu, navigation leads to the setting, “Alarm Latch”. Along the way, other alarm settings are bypassed and their values remain unchanged.
- At the alarm-latch setting, the value is changed from “off” to “on”.

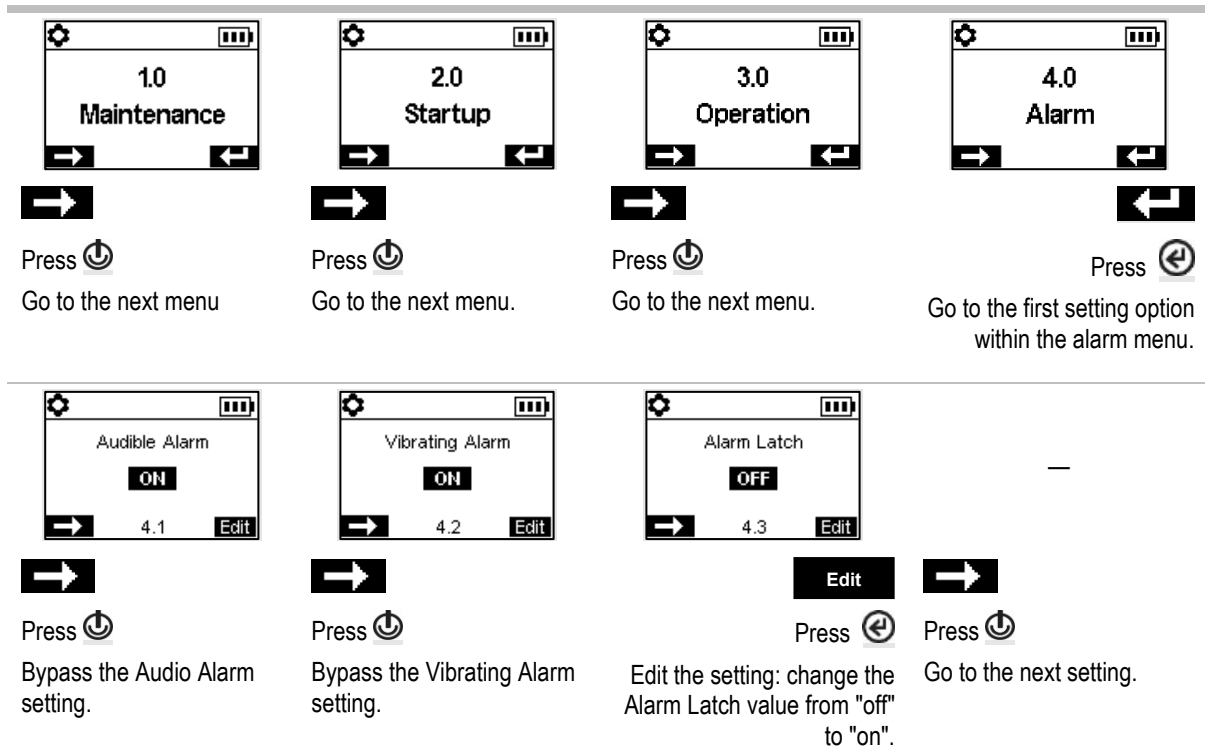

Figure 4.1.A Example for editing a single-item setting

*Example 2. Editing a multi-item setting*

Goal: Change the high-alarm setpoint for H<sub>2</sub>S.

- Follow the navigation from *Example 1* above.
- The navigation shown below then bypasses setpoints for the O<sub>2</sub>, LEL, and CO sensors; their values remain unchanged.
- The H<sub>2</sub>S event setpoint screen is a five-item setting. The navigation bypasses the first two settings, the gas-alert and low-alarm setpoints; their values remain unchanged.
- The H<sub>2</sub>S high-alarm setpoint is then highlighted for editing. Its value is changed from 20.0 ppm to 19.0 ppm.

<p>Press    Bypass the settings for O<sub>2</sub>.</p>	<p>Press    Bypass the settings for LEL.</p>	<p>Press    Bypass the settings for CO.</p>	<p>Press    Highlight the first setpoint for H<sub>2</sub>S (gas alert).</p>

---

			<p>—</p>
<p>Press    Bypass the gas-alert setting.</p>	<p>Press    Bypass the low-alarm setting.</p>	<p>Press    Edit the value for the high-alarm setpoint.   Press the button until the desired value of 19.0 is displayed.</p>	<p>Press    Save the new high-alarm setpoint value; go to the next H<sub>2</sub>S setting.</p>

---

		<p>—</p>	<p>—</p>
<p>Press    Bypass the STEL alarm setting.</p>	<p>Press    Bypass the TWA alarm setting.</p>		

Figure 4.1.B Example for editing a multi-item setting

## Reviewing and Editing Settings

The rest of this chapter describes in detail the settings and options available within each menu. Instruction is provided for navigating each menu and adjusting its settings.

When navigating and editing settings, the instrument will wait approximately 60 seconds between button presses; when no button is pressed, it will exit settings and re-enter start-up. To return to settings from start-up, simultaneously press and hold, then release and .

## Maintenance menu

The maintenance menu options related to these topics:

- Utilities and instrument information
- User-site assignments, iAssign, and iNet Now

### Utilities and instrument information

Perform any of these utilities:

- Zero the installed sensors.
- Calibrate the instrument.
- Bump test the installed sensors.
- View and optionally reset to zero each summary reading (peak, TWA, or STEL reading). When any summary reading is reset to zero, its time-related setting is also reset to zero.

Locate this basic instrument information:

- View the model, serial number, firmware version, and boot loader version.
- View regulatory and wireless information.
- Learn when the instrument is next due for docking or calibration or when it was last calibrated.

### User-site assignments

View the instrument's user and site assignments, and optionally change those assignments from the list of available values. If the desired user or site is not listed, use iNet Control or an iAssign accessory to complete the assignment.

*Note:* When a user or site assignment is made to the instrument using iNet Control, DSSAC, or Accessory Software, the instrument classifies the entered user or site as a recurring assignment. When an assignment is made to the instrument using an iAssign accessory, the instrument treats it as a temporary assignment.

## NFC

When set to on, NFC (near field communication) permits the instrument to do the following.

- Use "pairing" to join any LENS group, an unnamed, ad hoc formed group or a named group.
- Accept data from iAssign accessories.

If the Standby Clip™ is in use, it will place in standby status man down and other selected instrument functions (for standby settings options, see [Alarm menu](#)).

If the iAssign Beacon is in use, see also "Bluetooth" (below).

Use the "Clear iAssign" setting to control how iAssign data are to be cleared from the instrument. Choose from these options:



- Select "Overwrite" to allow iAssign accessories to overwrite the instrument's user, site, and access-level data. This setting is suitable for applications where workers are to use iAssign accessories in the field to change the instrument's current assignments.
- Select "Restart" or "Charging" to allow the instrument's user, site, and access-level data to be cleared only when the instrument experiences a restart or charging event, respectively.

*Note:* The NFC functionality of Ventis Pro 5 is not operational during normal operation when 17155304-Q, 17155304-S or 17155304-T sensor is installed. It is recommended to update the iAssign at start up settings to utilize user assignment feature.

## Bluetooth

Use the Bluetooth setting to allow the instrument to communicate with the compatible smart-device gateway or the iAssign Beacon; otherwise, Bluetooth can be turned off.

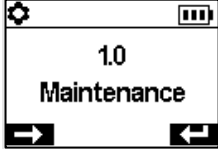
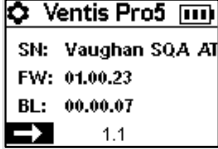
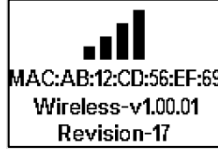
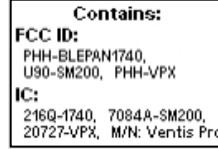
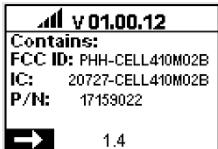
- If the facility uses iAssign Beacons, choose a setting option that includes *local*.
- If the instrument is to be monitored by iNet Now, choose an option that includes *iNet Now*.

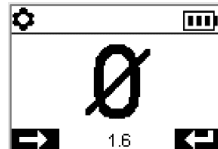
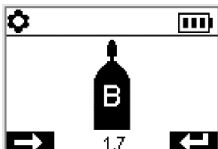
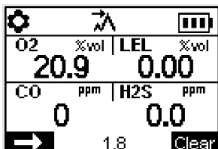
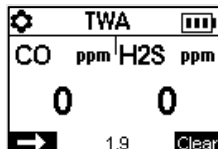
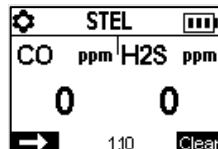
<p>Maintenance menu</p>  <p>Next menu      Go to first maintenance option</p>	<p>Instrument information</p>  <p>Next option</p>	<p>Wireless information</p>  <p>Next option</p>	<p>Regulatory information</p>  <p>Next option</p>
<p>Wireless battery information</p>  <p>Next option</p>	<p>Dock status</p>  <p>Next option      View span values</p>	<p>Calibration status</p>  <p>Next option      View span values</p>	<p>Zero and calibration utilities</p>  <p>Next option      Start utility</p>
<p>Bump test utility</p>  <p>Next option      Start utility</p>	<p>Peak readings</p>  <p>Next option      Clear peak readings</p>	<p>TWA readings</p>  <p>Next option      Clear TWA readings</p>	<p>STEL readings</p>  <p>Next option      Clear STEL readings</p>

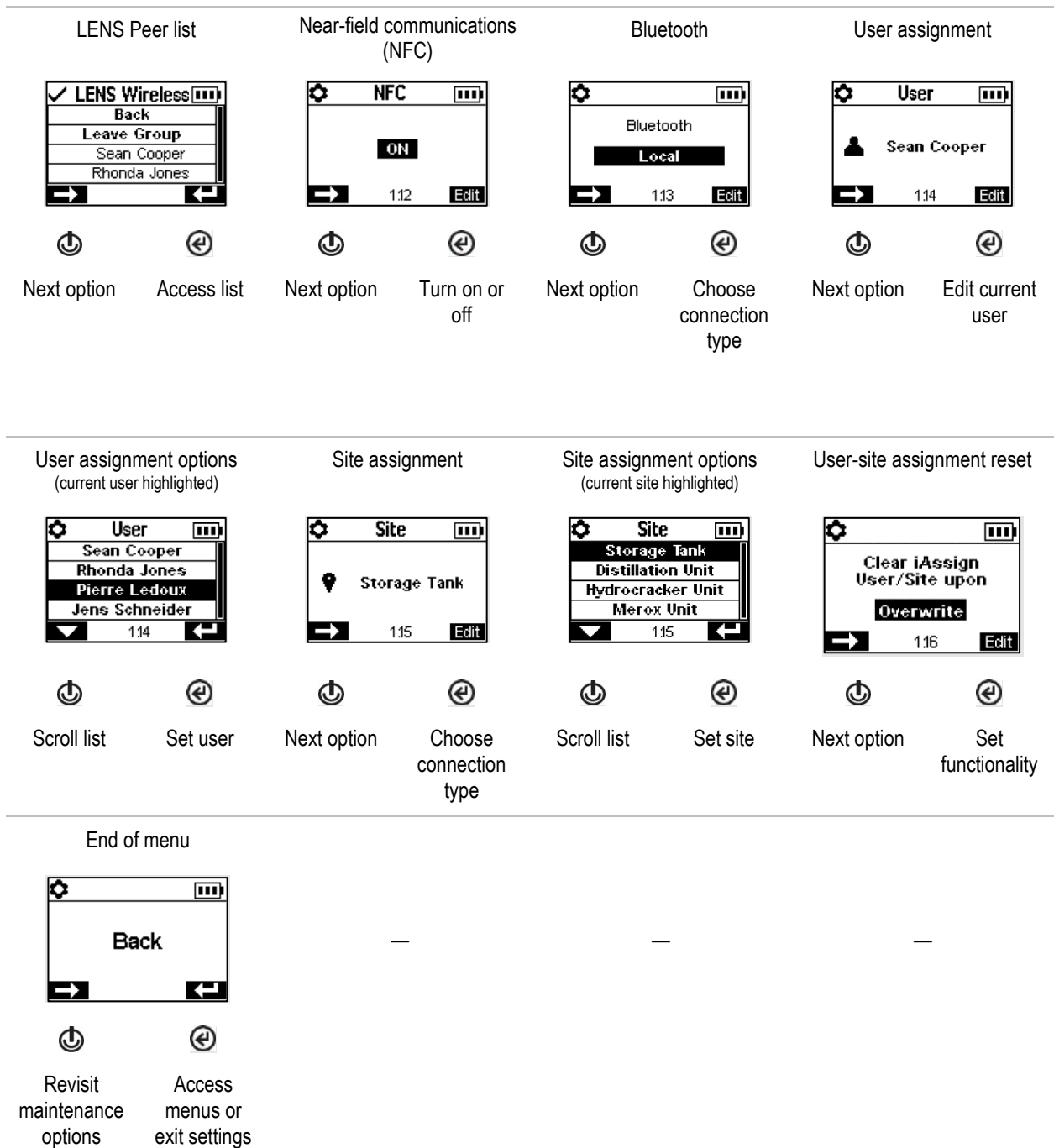

Figure 4.2.A Navigating and using maintenance options

## Start-up menu

Control how the instrument will interact with its operator during start-up.

Prompt or don't prompt for the use of an iAssign tag for user-site data.

Prompt or don't prompt for the use of an iAssign tag to update network credentials for an instrument that is equipped with a wi-fi battery.

Permit or prohibit all-user access to each item listed below.

Maintenance utilities:

- Zero the installed sensors.
- Bump test the installed sensors.

Maintenance status message:

- No message.
- The number of days until the next dock is due.
- The number of days until the next calibration is due.
- The number of days since calibration was last performed.

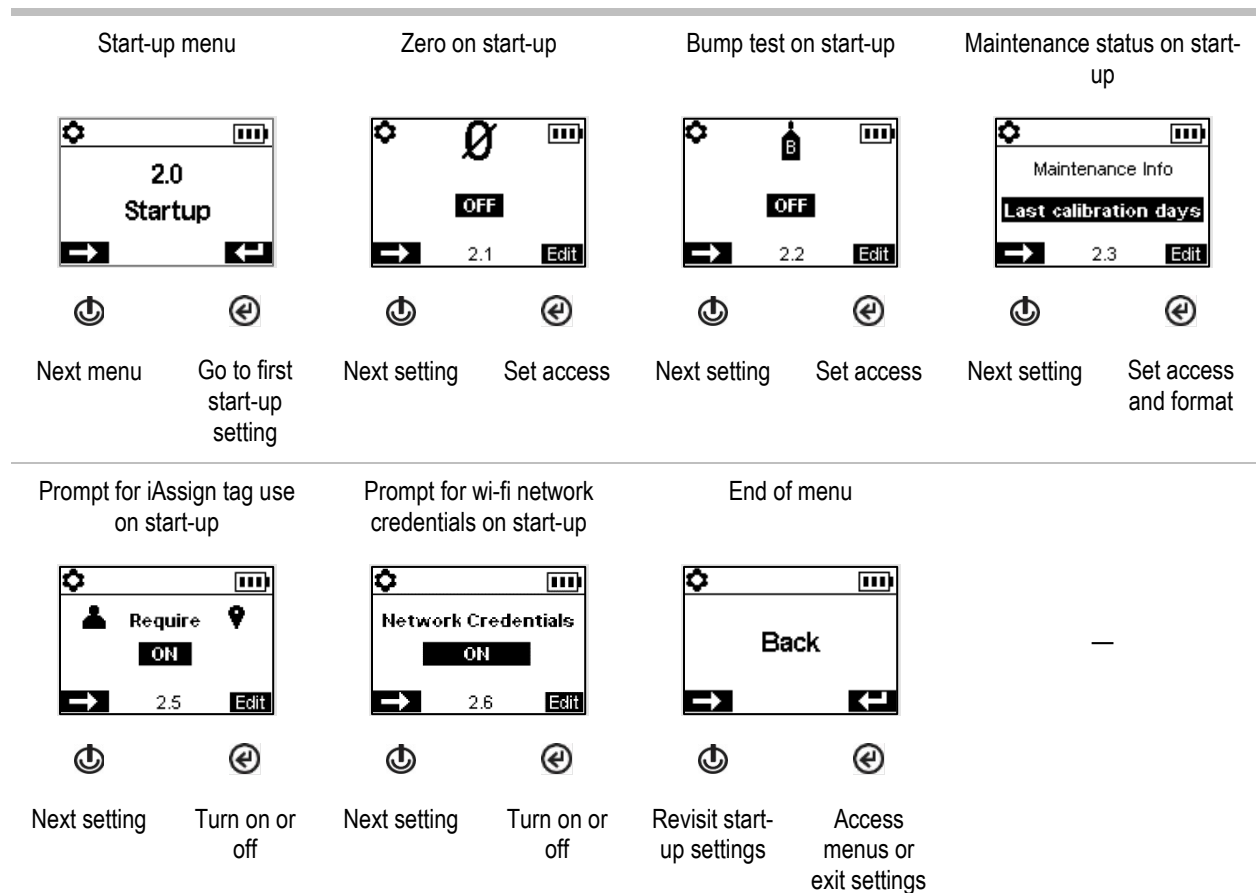

Figure 4.2.B Navigating and editing start-up settings

## Operation menu

Control how the instrument will behave during operation.

Permit or prohibit all-user access, during operation, to each of the items listed below.

### Utilities:

- Zero the installed sensors.
- Calibrate the instrument.
- Bump test the installed sensors.
- View and optionally clear each summary reading (peak, TWA, or STEL). *Note:* When an instrument operator clears any summary reading, the value is reset to zero and its time-related setting is also reset to zero.

*Note:* If a CO<sub>2</sub> sensor is installed, it will be zeroed along with any other installed sensors *only if* the "Zero CO<sub>2</sub>" setting is on.

### Information:

- The instrument's current assignments for user, site, or both
- A maintenance message about scheduled docking or calibration activities
- The gas information for all installed sensors: the values for the gas alert and alarm setpoints, and the calibration gas and concentration

### Set this functionality

- Permit or prohibit all-user access to the instrument's LENS Wireless peer list.
- Permit or prohibit the use of iAssign accessories during operation; set Edit User/Site to on.
- Permit all-user power off or set the instrument for "always-on" operation\*.
- Set the instrument to display the ambient air temperature in Celsius or Fahrenheit.

\*Always-on functionality also requires a valid security code setting (see the settings menu 6.0 Admin).

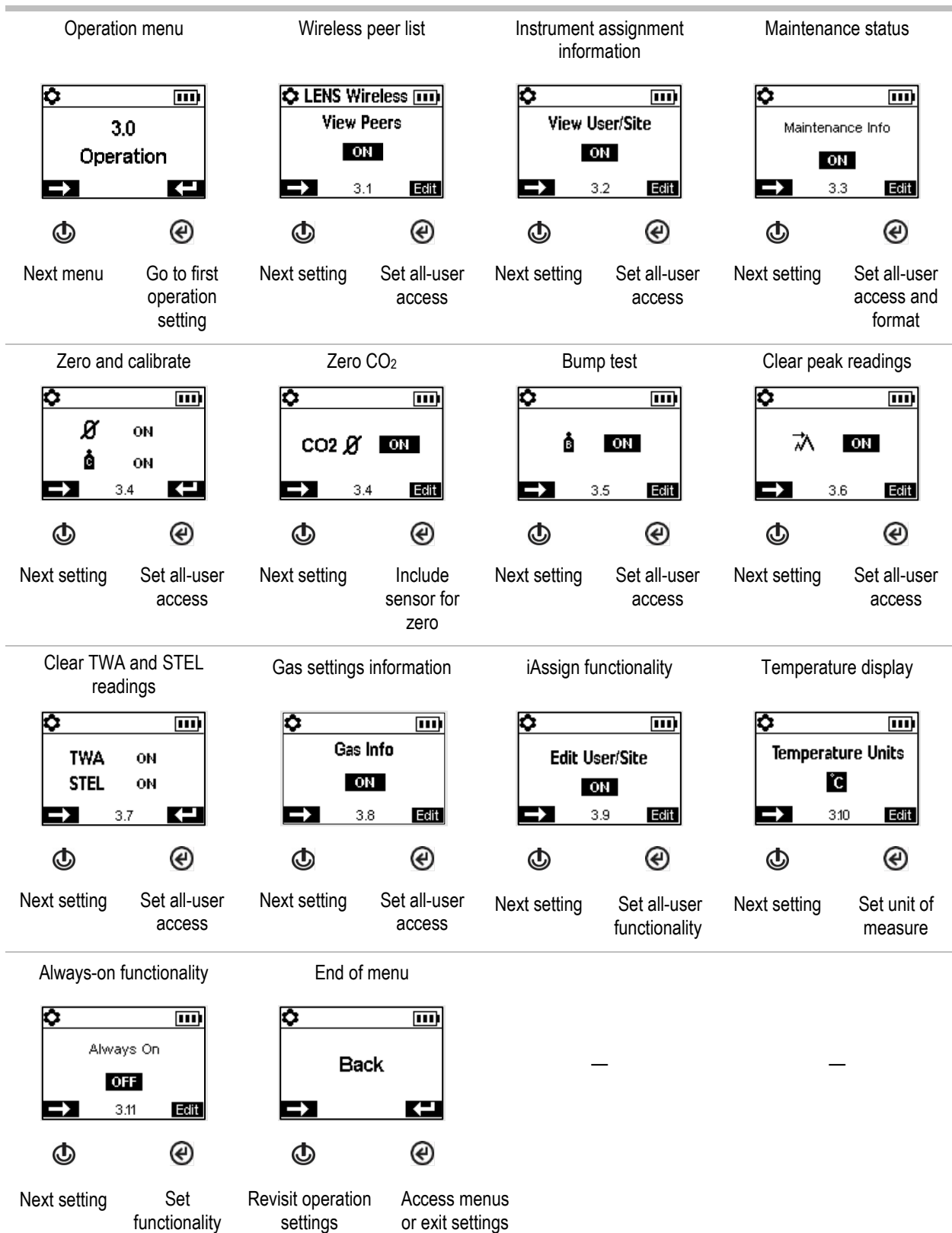

Figure 4.2.C Navigating and editing operation settings

## Alarm menu

Control how the instrument will behave for alarm-producing conditions.

Set for each sensor, the concentration of gas that will cause each possible gas event listed below.

- gas present, alert
- gas present, low alarm
- gas present, high alarm
- TWA
- STEL

*Note:* The navigation will start with the first setpoint for the *first sensor*, then the second setpoint for that same sensor, and so on through the last setpoint for the sensor. The navigation will then go through the same pattern for the *next sensor*.

Set the TWA time interval for toxic sensor readings.

Permit or prohibit instrument power off during alarms.

Set the on-off functionality for the man-down feature; set the amount of time that will lapse between the man-down warning and its alarm.

Set the on-off functionality for the proximity alarm. When set to on, the instrument proximity alarm is activated when the instrument enters an iAssign Beacon restricted-access area where the access-level setting of the Beacon is higher than that of the instrument's current user assignment. User access-level settings can be edited using the iAssign app or through iNet. When edited through the iAssign app, the change is immediate upon tapping the adjusted iAssign tag to the instrument. iNet changes take effect *after* an instrument is next docked.

Set the on-off functionality for each option listed below.

- audible alarm
- vibrating alarm
- full-screen alarms
- gas-present alert
- alarm latch
- alarms while docked
- gas reading while alarm latch

Set the SCBA (self-contained breathing apparatus) alarm-snooze option to allow or prohibit the worker to snooze SCBA-affected gas alarms. Use iNet to set the snooze duration and affected alarms.

Set which functions will go on standby any time the instrument is equipped with a Standby Clip. Choose from the following options.

- Man down
- Man down and gas
- Man down and peer
- Man down, gas, and peer

*Note:* When the Standby Clip is detached from the instrument, standby functions are re-enabled within about 5 seconds.

Select one of the options below to control STEL and TWA alarm functionality from a single display.

- Off – Both STEL and TWA functionality disabled
- On – Both STEL and TWA functionality enabled

- STEL off – TWA functionality enabled
- TWA off – STEL functionality enabled

Alarm menu		Audible alarm		Vibrating alarm		Alarm latch	
Next menu	Go to first alarm setting	Next setting	Turn on or off	Next setting	Turn on or off	Next setting	Turn on or off

Alert and alarm setpoints (H2S shown)

Gas present, alert		Gas present, low alarm		Gas present, high alarm		STEL alarm	
Next setting	Edit value	Next setting	Edit value	Next setting	Edit value	Next setting	Edit value

TWA alarm		TWA interval <sup>a</sup>		Shutdown in alarm		Alarm while docked	
Next setting	Edit value	Next setting	Edit value	Next setting	Turn on or off	Next setting	Turn on or off

Man-down warning and alarm		Gas-present alert		Full-screen alarms		Proximity alarm	
Next setting	Turn on or off; edit delay value	Next setting	Turn on or off	Next setting	Turn on or off	Next setting	Turn on or off

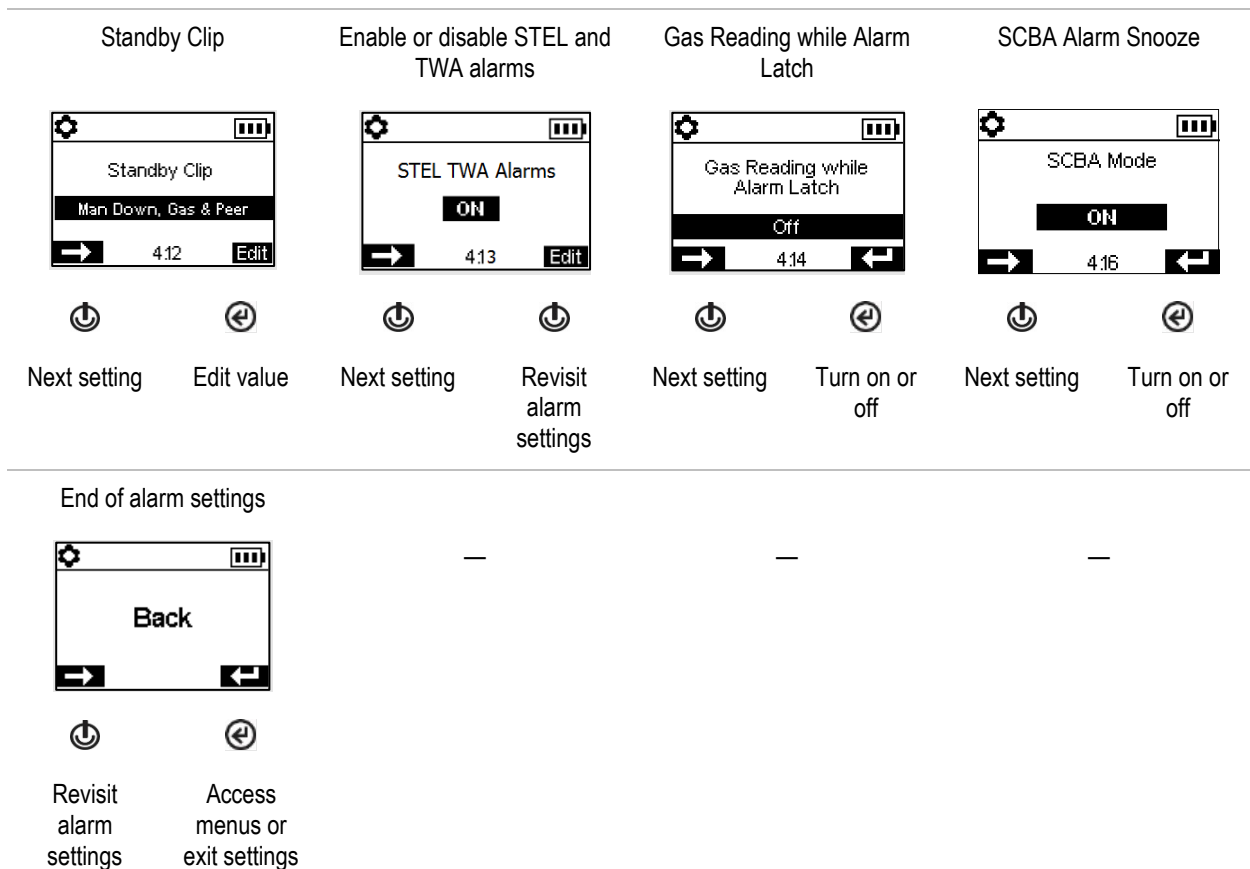

Figure 4.2.D Navigating and editing alarm settings

<sup>a</sup>The TWA interval on the instrument can be configured anywhere from 1 to 40 hours.

## Sensor menu

Depending on the installed sensors, display screens may vary.

Control settings related to calibration and bump testing:

- Choose the "quick" or "standard" process for calibration and bump testing.
  - Quick process.* This process allows for only one application of gas. It is well suited for installed sensor combinations that use a calibration gas cylinder of the "blended" type—one that contains the gas types and concentrations required for *all* installed sensors.
  - Standard process.* This process allows for more than one application of gas. It provides time—between sensors—for the change of cylinders. It is well suited for installed sensor combinations that require more than one calibration gas cylinder.
- Set calibration gas concentrations for each sensor and the correlation factor for an LEL sensor.

View the location of each installed sensor and its span reserve percentages. *Note:* An indicator of a sensor's remaining life, the span reserve percentage will decline over time; when its value is less than 50%, the sensor will no longer pass calibration.

Each sensor has a deadband value, which allows it to measure the low-level presence (or lack) of a gas but *display* a reading of zero. For example, if the deadband value for a CO sensor is 3 ppm, any positive CO measurement up to and including +3 ppm will produce a display-screen reading of 0 ppm. Likewise, a negative CO measurement down to and including -3 ppm will produce a reading of 0 ppm.

To allow the instrument to display as zero any gas measurements within the deadband, set the deadband to *on*. To allow the instrument to display the sensor's actual reading when the detected level of gas is within the deadband, set the deadband to *off*.

**Table 4.3 Deadbands**

Gases	Part Number	Deadband
Carbon Monoxide (CO)	17155306-1A	3 ppm
Hydrogen Sulfide H <sub>2</sub> S	17155306-2A	0.5 ppm
Oxygen (O <sub>2</sub> )	17155304-YA	0%
LEL (Methane)	17155304-LA	2% LEL
Carbon Dioxide (CO <sub>2</sub> )	17155304-UA	0%

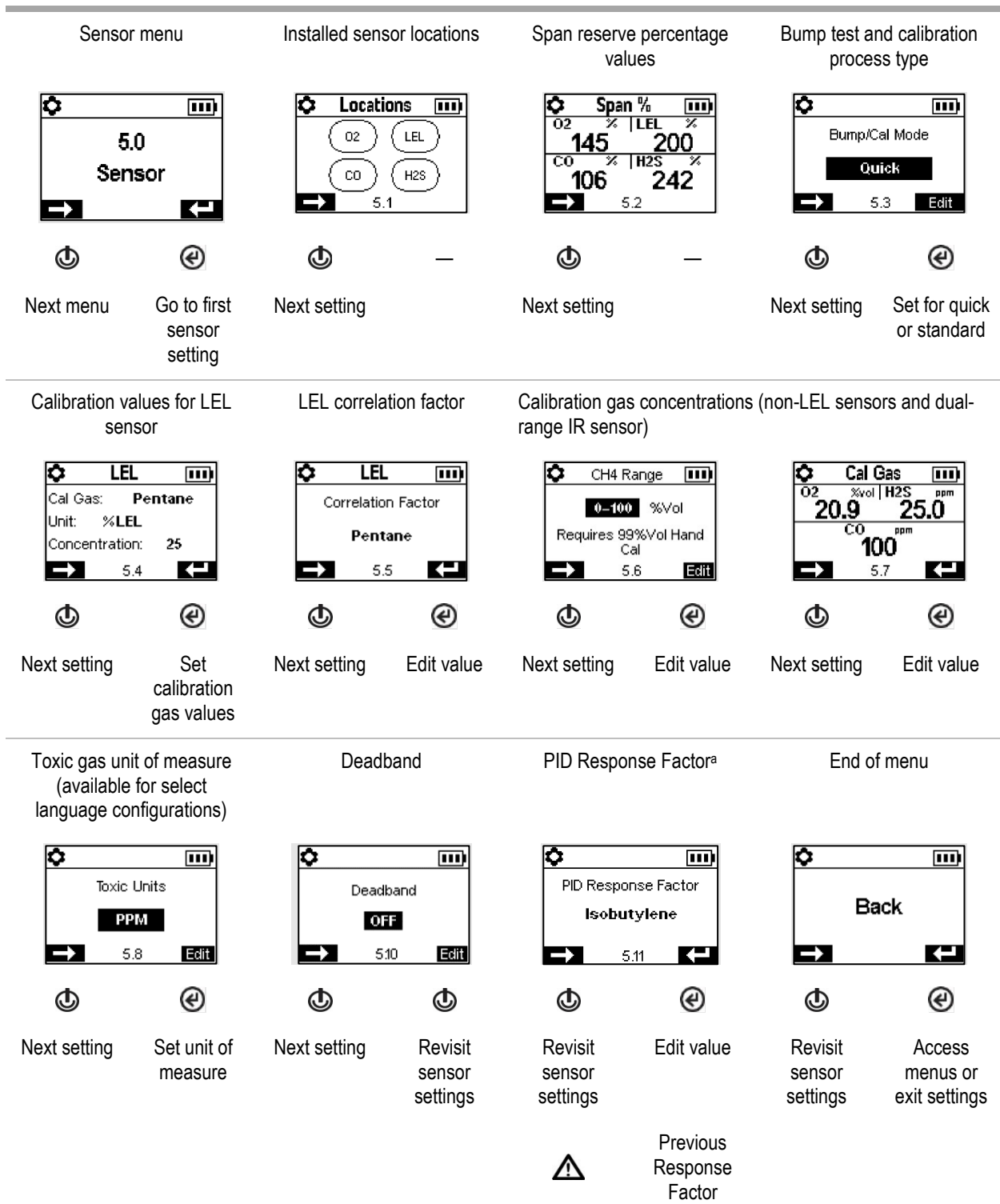

Figure 4.2.E Navigating and editing sensor settings

<sup>a</sup>The response factor setting on the instrument can be turned on or off using iNet. Additionally, a custom response factor can be set through iNet.

## Admin menu

Control the ways in which an instrument will interact with its user and set time-based values that are related to the data-log entries and bump testing.

To help protect access to settings, set the instrument's security code value to any three-digit number from 001 to 999. A value of 000 will leave settings *unprotected* and potentially accessible all instrument users.

A security code of 001-999 is also required for the use of always-on functionality; if set to 000, an always-on unit can be powered off without a security code.

Sensors pass a bump test when they sense the specified percentage of calibration gas (or "pass limit") within the specified response-time setting. Set the bump test criteria for these two values:

- a pass limit value from 50 to 99%
- a response-time value from 30 to 120 seconds

*Note:* For calibration gas recommendations, see "Table 2.7, Sensor specifications".

Turn on or off each of these warnings: scheduled bump test due, scheduled calibration due, and scheduled dock (or "synch") due. For each warning that is set for on, set these two values:

- a warning type of audible only, visual only, or both audible and visual
- the maintenance interval (set in one-day increments for dock and calibration and half-day increments for bump test)

The confidence indicator emits a signal every 90 seconds to indicate to the user and others who are nearby that the instrument is powered on. If the indicator is set for on, choose a signal type of audible only, visual only, or both audible and visual.

Set the LENS Warning to off or to on. When set to on, the instrument will warn its operator that it is not part of LENS group.

Set the iAssign warning to off or to on for user only, site only, or user and site. When set to on, the instrument will warn its operator of missing assignments.





Set the iAssign update setting to one of these options.

- tone disabled and vibration enabled
- both tone and vibration enabled
- both tone and vibration disabled

When an update method (tone or vibration) is enabled, the instrument notifies its user when iAssign user-site settings are changed using the enabled method.

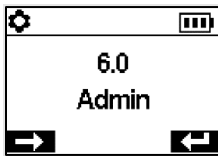
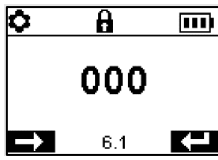
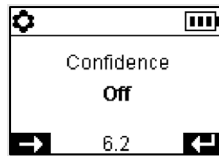
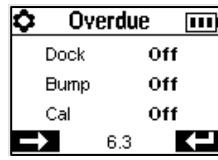
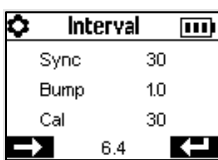
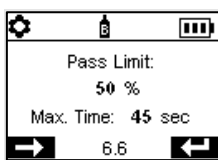
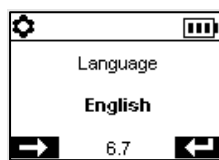
Set the instrument's display language.

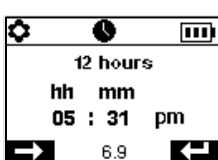
To support data-log integrity, set the date and time; these values are associated with gas-readings and event data that are saved to the data log.

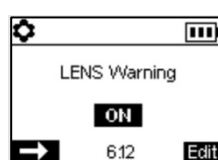
<p>Admin menu</p>  <p>Next menu      Go to first admin setting</p>	<p>Security code</p>  <p>Next setting      Edit value</p>	<p>Confidence indicator</p>  <p>Next setting      Turn off warning or set warning type</p>	<p>Scheduled maintenance warnings</p>  <p>Next setting      Turn off warnings or set warning types</p>
<p>Maintenance intervals</p>  <p>Next setting      Set interval (days)</p>	<p>Bump test criteria</p>  <p>Next setting      Edit percentage and time</p>	<p>Display-screen language</p>  <p>Next setting      Choose display-screen language</p>	<p>Current date</p>  <p>Next setting      Edit values</p>
<p>Current time</p>  <p>Next setting      Edit values</p>	<p>iAssign warning</p>  <p>Next setting      Turn off warning or set warning type</p>	<p>iAssign update tone</p>  <p>Next setting      Edit values</p>	<p>LENS warning</p>  <p>Next setting      Turn on or off</p>

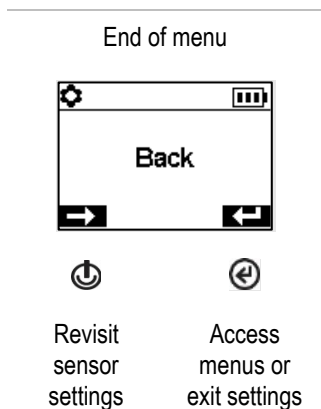

Figure 4.2.F Navigating and editing admin settings

## Wireless menu

Control how the instrument will operate with respect to connected safety.

Set the LENS Wireless mode.

- If the instrument will *not* use LENS Wireless, choose off. LENS symbols won't display in the status bar.
- If the instrument will use LENS Wireless, but will *not* be monitored by iNet Now, choose *Local*. Cloud symbols won't display in the status bar.
- If the instrument will use LENS Wireless *and will* be monitored by iNet Now\*, choose the combined option, *iNet Now and local*.

\*Requires activation of the iNet Now service, plus instrument activation (using iNet) for live monitoring.

Each LENS group can host up to 25 equipment items, including Ventis Pros, Radius BZ1s, and compatible gateways.

*Note:* The maximum LENS group size varies for these specialized applications: 1.) six, including at least one Ventis Pro, when a smart-device gateway is in use and 2.) eight when an RGX Gateway is used and set to Dynamic Monitoring for plume modeling.

Use the LENS Group setting to control how the instrument can join groups. As described below, the options are *Scan*, *Manual*, or a named group such as *Group A*.

### *Scan*

Choose "*Scan*" to allow the instrument to scan for and automatically join a LENS group. The instrument will scan for LENS groups within range, selecting the best group to join based on network strength and number of LENS peers in the group. The instrument will continue to scan until it detects and joins an available LENS group with a vacancy.

*Note:* In Scan mode, with LENS Wireless set to *iNet Now and local*, the instrument will scan until it finds and joins a group containing a gateway.

### *Manual*

If the worker is expected to join and leave LENS groups as needed, choose the setting value of "*Manual*". This allows the instrument to use NFC pairing to manually join a group, so ensure the NFC setting is on (see Maintenance settings menu) when selecting this value.

*Note:* A setting value of scan or manual will permit the instrument to join any LENS group—an unnamed, ad hoc formed group or a named group (e.g., *Group X*).

### *Named Group*

If the instrument does *not* need to join and leave different LENS groups, you can assign it to a named group, such as "Group A". When set to a named group, an instrument *cannot* join any other LENS group without changing the setting to *Scan*, *Manual*, or a different named group.

*Note:* The named group setting value options are "A" through "J".

Determine how the instrument interacts with its user about LENS peer alarms and warnings.

- Set the instrument's peer alarm off or set its signal type to audible only, visual only, or both audible and visual. When set to off, peer alarms will be indicated *only* on the display screen.
- Set the instrument's peer-lost and no-peer warnings to on or off. When set to off, the instrument *will not in any manner* warn or notify its operator of these occurrences.

Control a battery's wi-fi or cellular operation.

Set the wi-fi or cellular on or off.

- Use a setting of *off* to allow the battery to power the instrument, but to disallow the battery's wireless functionality. Cellular and wi-fi symbols won't display in the status bar. When off, GPS is disabled.
- Use a setting of *on* to allow the battery to power the instrument *and* to enable the battery's wireless functionality. When set to on and the wireless battery has a connection to iNet, details and GPS coordinates are immediately transmitted to iNet when any of these alarms and errors occur.

*Notes:* When a wireless battery is "out of range" (no connection to iNet), data *cannot* be transmitted to iNet. If this occurs, up to 15 events will be stored and transmitted to iNet by an instrument equipped with a wi-fi battery once a connection is reestablished. Instruments equipped with the cellular battery *do not have this feature* and *will not store* these events.

### *Alarms*

- Gas present, low alarm
- Gas present, high alarm
- Gas present, over-range (positive and negative)
- TWA
- STEL
- Man-down
- Panic
- Proximity
- Critical error

Set the noncritical message interval, the interval at which the wi-fi or cellular battery will collectively transmit data about the occurrences listed below. The interval value range is from 15 to 300 seconds.

### *Process status*

- Zero failure
- Calibration failure
- Bump test failure

### *Updates*

- User name
- Site name

Set Sync while charging on or off. When set to on, the instrument will be permitted to sync with iNet Now when it is placed in the charger *and* the in-range smart device is running the iNet Now Sync app.

Determine how the instrument notifies its user of a lost wireless (iNet, wireless, cellular, or bluetooth) connection. Set the Connection-lost warning signal to off, audible, visual, or visual and audible.

Note: For instruments with multiple wireless connections (iNet, wireless, cellular, or bluetooth) enabled, this notification will only occur when ALL available wireless connections are lost.

Use the LENS Wireless peer time-out setting as follows.

- If the worker needs to briefly see peer readings, choose the 30-second value.
- If the worker is expected to continuously monitor the gas readings of a LENS-group peer, set the peer time-out to off. *Note:* This will *not* prevent the instrument from notifying its operator of any gas, man-down, panic, or low-battery events that may occur; likewise, if either the peer under view or the LENS connection is lost, the instrument will notify its user of these occurrences.

Use a custom encryption key or the instrument's default key from Industrial Scientific. The custom key can be set through iNet or DSSAC. Equipment items in the same named LENS group must use the same key.

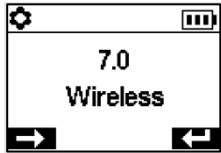
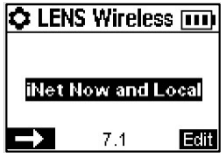
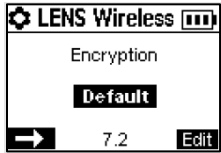
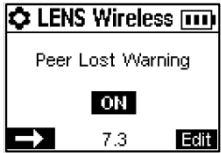
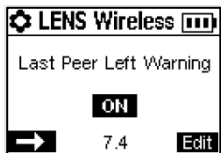
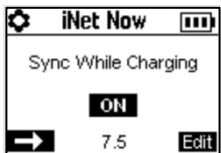
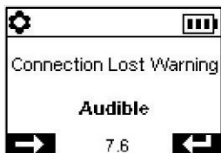
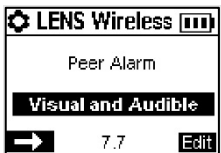
<p>Wireless menu</p>  <p>Next setting      Go to first wireless setting</p>	<p>LENS Wireless (mode)</p>  <p>Next setting      Turn off or select mode</p>	<p>LENS Wireless encryption</p>  <p>Next setting      Turn off encryption or select encryption key</p>	<p>LENS Wireless peer-lost warning</p>  <p>Next setting      Turn on or off</p>
<p>LENS Wireless No peer warning</p>  <p>Next setting      Turn on or off</p>	<p>iNet Now Sync while charging</p>  <p>Next setting      Turn on or off</p>	<p>Connection-lost warning</p>  <p>Next setting      Select signal type</p>	<p>LENS Wireless Peer alarm</p>  <p>Next setting      Turn off or select signal type</p>

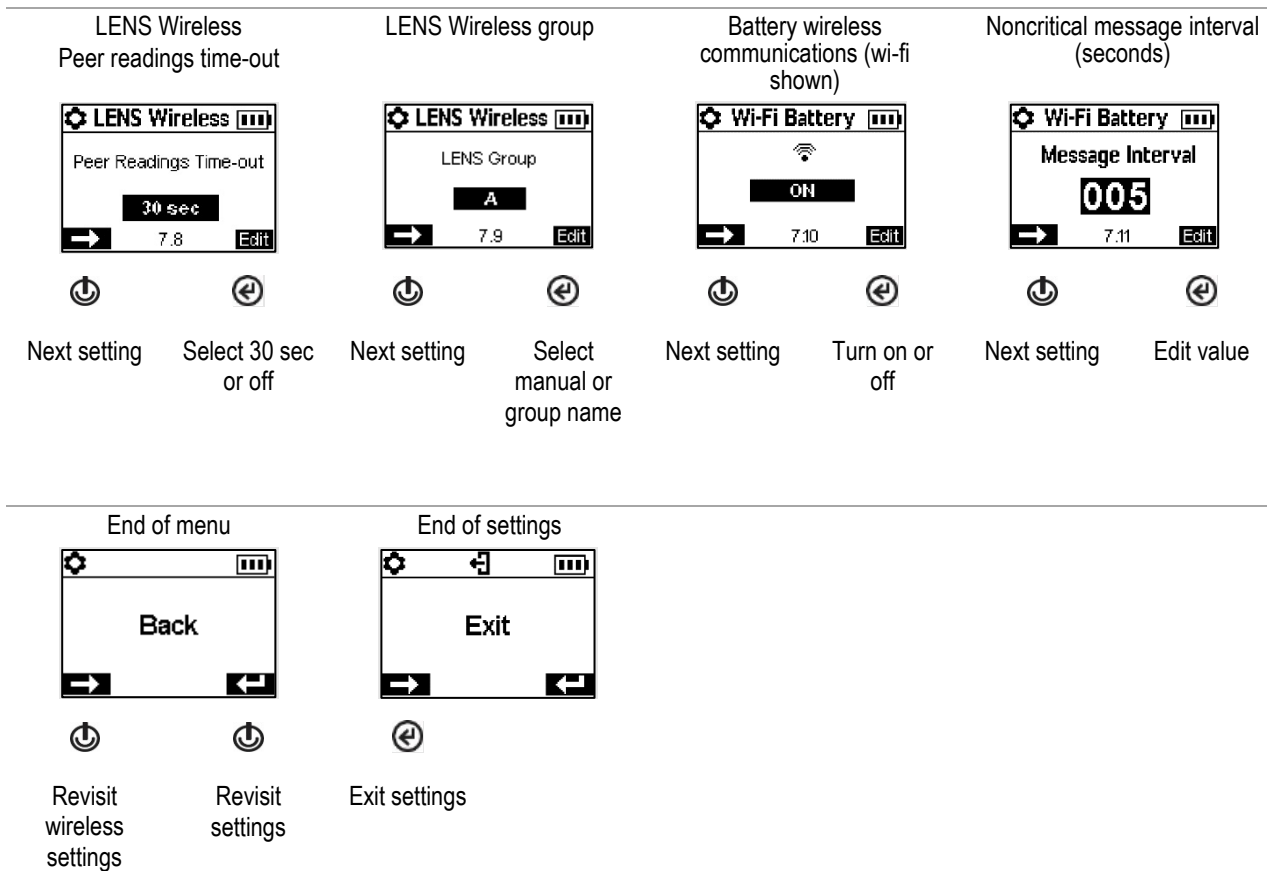

Figure 4.2.G Navigating and editing wireless settings

---

## Operation

The Instrument Buttons

The Instrument Display

Operating the Instrument

Wearing the Instrument

iAssign Accessories

LENS Wireless

Live Monitoring

Man Down

Alarms and Warnings At-a-glance

---

## The Instrument Buttons

Ventis® Pro Series instruments have three buttons, the power button, the enter button, and the panic button. During operation, the buttons are used as described below in Figure 5.1.

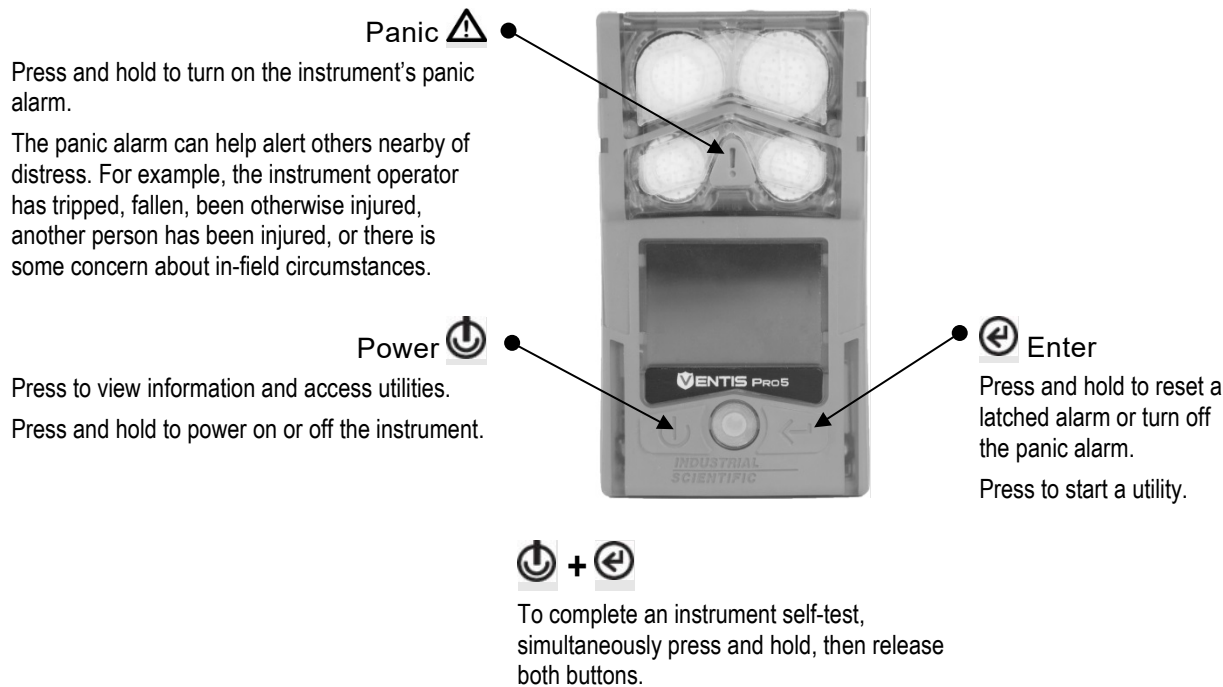

Figure 5.1 Using the buttons during operation

## The Instrument Display

After a unit has been powered on—its self-test and start-up sequence successfully completed—the gas readings should display. This display screen is referred to as “Home”, which will generally look like the samples shown below for a five-gas instrument (enlarged for detail) and a four-gas instrument. During operation, the home screen will display unless the instrument is using the display to provide information about an alarm, warning, indicator, or status item, or the instrument operator has accessed another option.

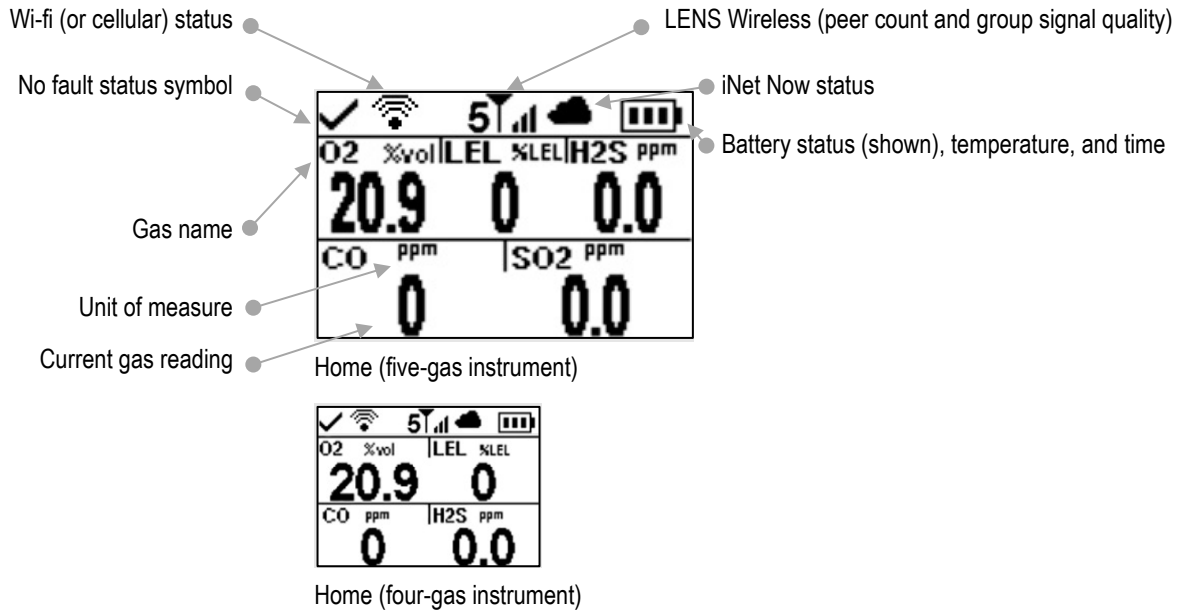

Figure 5.2 Home

## Operating the Instrument

From the home screen, a series of display screens may be accessible depending on the unit's settings, and may include any or all of the options listed below.

The LENS® Wireless peer list provides access to the following.

- The list of equipment items\* in the group with each group hosting up to 25 peers.
- The gas readings for any peer instrument.
- The RGX® Gateway information screen.
- The option to leave the group.

\*If a peer instrument is not assigned to a user name, its serial number or MAC address will be shown in the peer list.

The wi-fi and cellular battery display screens provide access to the following.

- The name of the connected wi-fi network (or cellular service provider).
- The cellular battery's [messaging feature](#), which is covered later in this chapter.
- The option to update the wi-fi battery's network credentials using an iAssign tag.
- GPS coordinates. The GPS lock symbol (📶) is present when the coordinates are being received via satellite; otherwise, the coordinates indicate the last-received GPS location.
- Battery firmware version number.

Other available information may include the following.

- Number of days until the instrument is due to be docked.
- Number of days until the instrument is due for calibration or the number of days since its last calibration.
- Gas-settings information (alert and alarm setpoints and calibration gas concentrations).
- Assignment information (the company, user, and site assigned to the instrument).

The worker may also have access to the options described below.

- Zero the installed sensors and optionally calibrate the instrument.
- Bump test the installed sensors.
- View and optionally clear the peak readings.
- View and optionally clear the TWA readings.
- View and optionally clear the STEL readings.
- View and optionally edit the response factor (RF) for an installed PID sensor.
- Use SCBA mode.

*Note:* When a reading is cleared, its value is reset to zero and its time-related setting is also reset to zero.

*Note:* When the PID RF is edited, the new setting will immediately be in effect. When the instrument is next powered off, the PID RF will revert to its prior setting. The response factor accuracy for the PID sensor is 20%.

Figure 5.3 (below) describes and illustrates how to access worker options, which vary based on instrument settings. The sample display screens shown here feature a mix of 3-, 4-, and 5-gas formats.

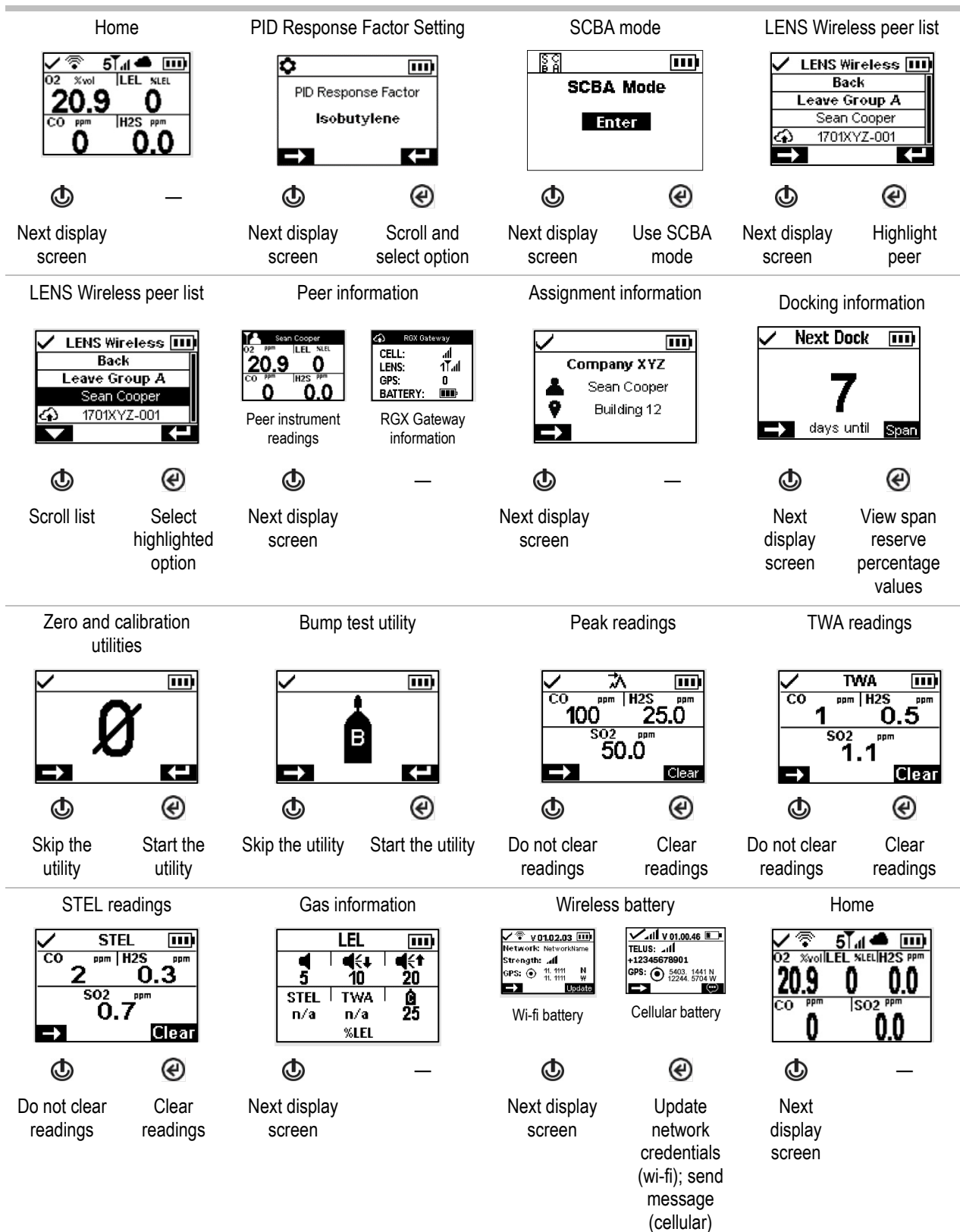

Figure 5.3 Operation instruction

# Wearing the Instrument

The instrument may be worn with its factory-installed clip, which is solely intended for attachment to a garment.

As shown below, the clip should be securely fastened and attached in a manner that ensures the instrument's sensor ports are fully exposed to the air. No part of the instrument should be covered by any garment, part of a garment, or other item that would restrict the flow of air to the sensors or impair the operator's access to the audible, visual, or vibration alarms.

---

Garment clip (diffusion instrument shown)



Lift the clip cover.



Position the garment between the clip's upper and lower teeth.



Press down on the clip cover to secure the clip in place.

---

## iAssign Accessories

### iAssign Tags and Beacon

*iAssign*<sup>®</sup> Tags, which use NFC (near field communication) technology, are customer programmable using the *iAssign* app. When a worker's *iAssign* tag is programmed to contain identifiers such as user or site, then tapped to a Ventis Pro (see below), it will update instrument settings with the tag's identifiers.

If a tag is programmed to include an "access level", which is associated with the tag's user name, it will be passed to the instrument upon tag tapping. Based on that value, the instrument will activate its proximity alarm when within range of an *iAssign* Beacon broadcasting a higher access-level value, notifying the instrument user of a beacon "restricted area".

*iAssign* tags can also be programmed to update network credentials for an instrument that is equipped with a wi-fi battery. To make the update, access the instrument's *battery information screen*, choose *Update*, then tap the *iAssign* tag to the instrument. See Appendix B for wi-fi battery related programming instructions.

*iAssign* Beacon settings are managed using a smart device that is running the *iAssign* app. Settings include identifiers (e.g., site) and other values such as access level and range.

*Note:* An instrument's settings may or may not permit the use of *iAssign* technology.

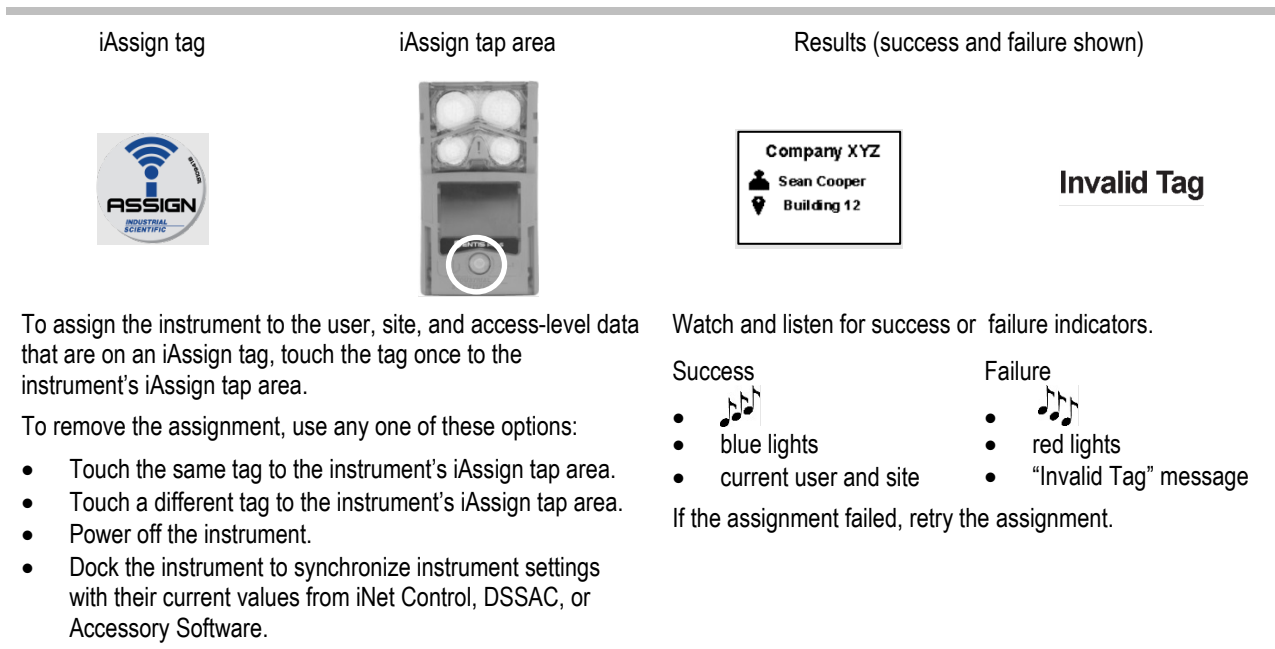

Figure 5.4 Using iAssign Tags

## Standby Clip

The Standby Clip™ accessory snaps over the front of a Ventis Pro instrument. When in use, the clip's permanently locked, factory-programmed iAssign tag serves to place selected functions on standby, meaning those functions are not operational. Standby status includes man down and, depending on instrument settings, may also include gas detection and peer alarms. As shown in the figure below, symbols on the display screen indicate which functions are on standby.

When the Standby Clip is detached from the instrument, any functions that had been on standby are re-enabled within approximately 5 seconds.

While the Standby Clip is in use, the instrument panic alarm remains operational.

*Note:* If the instrument battery charge falls to a critical low level, standby status will become disabled or will operate intermittently.

For more information about the Standby Clip, see the *Standby Clip Guide*, part number 17159437.



Ventis Pro with Standby Clip (man down and gas readings on standby)

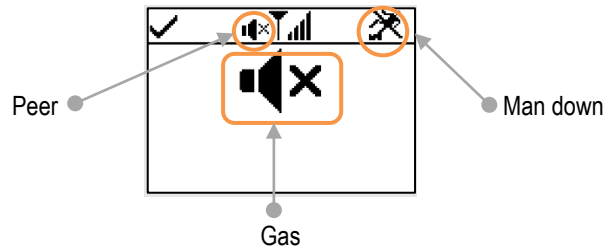

Man down, peer, and gas detection on standby

Figure 5.5 Operation display screen (Ventis Pro with Standby Clip)

## LENS Wireless





### LENS instrument basics

LENS® Wireless can wirelessly connect instrument "groups". A LENS group can include Ventis Pro instruments, Radius® BZ1 Area Monitors, and compatible gateways. Instruments that are connected through a LENS group are known as "peer instruments". On its home screen, the instrument indicates the number of peers it is connected to in the LENS group. Up to 25 instruments can belong to each group.

*Note:* The maximum size for each LENS group varies for these specialized applications: 1.) six when a smart-device gateway is in use and 2.) eight when a peer RGX Gateway is used and set to Dynamic Monitoring for plume modeling.

Peer instruments share alarms, allowing instrument operators to learn of nearby hazardous conditions and the identities\* of colleagues whose instruments are in alarm. LENS also allows instrument operators to view peer-instrument gas readings on demand.

Equipment items in a LENS group communicate in a nonlinear manner. As shown below in Figure 5.5, messages can travel among instruments that may be separated by distance or a structure (gray bar). The following also apply to Ventis Pro instruments that are in a LENS group.

- To maintain membership in the group, use this guideline to assess potential signal reach: a line-of-sight distance up to 100 m (109 yd) between the Ventis Pro and another equipment item in the group.
- Check the home screen to assess the group's signal quality. From lowest to highest signal quality, the symbols are: , , , and .
- If an instrument becomes separated from its group, its display screen will feature a "Group Lost" message and its peer instruments, a "Peer Lost" message (if settings permit). When lost from its group, the instrument will make multiple attempts over five minutes to rejoin the group.
- LENS peer-alarm signals can be turned off by pressing ; details will remain visible on the display screen.

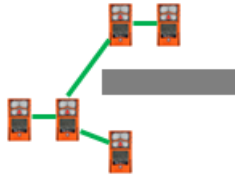
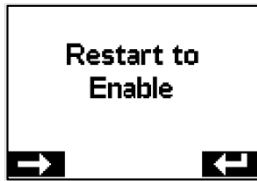

Figure 5.6 LENS group peer-instrument locations

\*Requires valid current user assignment; otherwise, the peer instrument's serial number or MAC address will display.

## Using Upgrade Cards

Upgrade cards can be used to add the instrument functionality needed for LENS Wireless. Simply touch the card to the front of the instrument. Then, follow the on-screen instructions and look for one of these results.



The upgrade was successful. Power off the instrument, then power it on. The feature-related symbol should now appear on the display screen; otherwise, see a supervisor.



The upgrade was not successful because the card's upgrades have all been used. Retry the upgrade with another card.

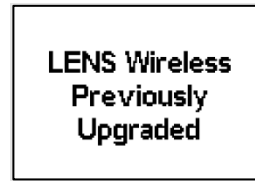

The instrument is equipped with the functionality. The instrument's related settings should be reviewed to ensure they are correct (e.g., LENS is set to "on").

## Joining a LENS group

When enabled for LENS Wireless, a Ventis Pro's group membership capabilities are determined by its LENS group setting of "Scan," "Manual," or a named group (e.g., "Group A").

- With the *scan* setting, the instrument scans for and can join in-range LENS groups with a vacancy.
- With a *manual* setting, the instrument can join and leave any LENS group as needed (see Figure 5.6).
- With a *named group* setting, the instrument can leave its group; however, it can join another LENS group *only when* its LENS group setting is changed to scan, manual, or to another named group.

When an instrument in a LENS group is set to manual, and tries to join a different group, the instrument will prompt its user to confirm the change; otherwise, it will simply signal and inform its user of the joining-attempt result and indicate any required actions.

Start

Ventis Pro to Ventis Pro	Ventis Pro to Radius BZ1	Ventis Pro to RGX Gateway

To join together Ventis Pro Series instruments, hold two instruments together—speaker to speaker—for approximately five seconds or until the instrument emits an ascending tone to indicate success.

To join a Ventis Pro Series instrument to a Radius BZ1 instrument, choose the "Join new peer" option on the Radius; this is accessible from the Wireless menu's Wireless Peer options.

Then, point the Ventis Pro IrDA window at Radius IrDA window. Hold the Ventis Pro very close to the Radius for approximately five seconds or until the Ventis Pro emits an ascending tone to indicate success.

To join a Ventis Pro Series instrument to an RGX Gateway, tap the RGX power button three times; its indicator light will flash red. Hold the Ventis Pro speaker against the RGX Gateway logo for five seconds or until the instrument emits an ascending tone to indicate success. Tap the RGX power button three times; its indicator light will change to reflect the gateway's current state.

Joining in progress



The joining process requires up to 30 seconds. During that time, the Ventis Pro will periodically display its gas readings.

Leave group confirmation



If the Ventis Pro is in an existing group, it will require confirmation from its user to leave that group. This allows the instrument to join the new group.

Home

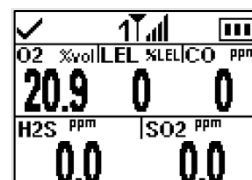

Once connected, the instrument's home screen will indicate the number of peers and group signal quality.

Figure 5.7 Join a LENS group via pairing

## Leaving a LENS group

There are three ways for an instrument to *intentionally* leave a group without activating group-related warnings.

- The operator accesses the instrument's LENS Wireless peer list and chooses the "Leave Group" option. As shown below, if the instrument is in a named group such as Group A, the group name is indicated onscreen.
- The instrument's LENS group membership is changed, either by manually joining another group or through settings.
- The instrument LENS group setting is scan.
- The instrument is docked or powered off.

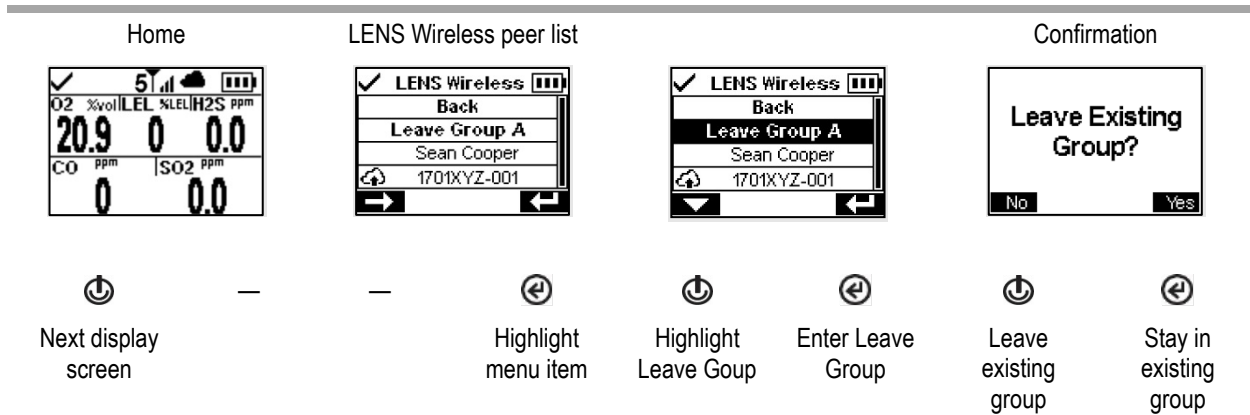

Figure 5.8 Leave a LENS group

## Peer gas readings

Figure 5.8 describes how to access the gas readings of a peer instrument. The duration of the peer reading depends on the instrument setting; it may be set to time out after 30 seconds or to persist.

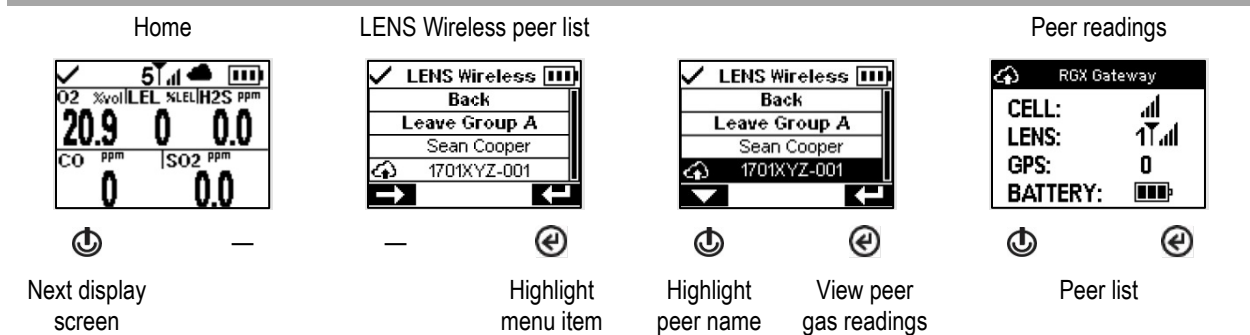

Figure 5.9 Access peer gas readings

## Live-monitoring Status

The live monitoring of gas-detection instruments is achieved through the *iNet Now* app where the safety team learns of in-field events as they occur and can immediately respond to potentially hazardous situations.







Live monitoring requires the following.

- Activation of the *iNet Now* service.
- Activation of the instrument (through iNet) for live monitoring.
- The Ventis Pro has a wireless connection to a compatible gateway, or the Ventis Pro is equipped with a wireless battery, or both.

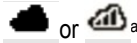
Notes: Instrument settings and connection guidelines also apply as described in this “Product Manual”. A smart-device gateway communicates with in-range Ventis Pro instruments regardless of an instrument’s LENS group status.

When present on the Ventis Pro display screen, cloud and wireless-battery symbols indicate the instrument’s live-monitoring status.

Table 5.1 Live-monitoring connection status

Cloud path or wireless type RGX or TGX Gateway, or smart device <sup>a</sup>	Connected	Lost (or no) connection
LENS wireless, Peers, and connection strength	 or 	
Wi-fi battery		
Cellular battery		











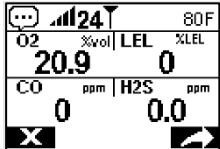

Notes: When the LENS mode setting option is set to off, LENS wireless symbols will not display in the status bar. When LENS mode is set to local, cloud icons will not display. If a cellular or wi-fi battery is installed, but its communication setting option is set of off, cellular and wi-fi symbols will not display. When an instrument has more than one wireless option enabled, multiple symbols will display.

## Messaging (Cellular Battery Option)

When the Ventis Pro5 is equipped with a compatible cellular battery, the worker can exchange text messages with preprogrammed cell-phone numbers (limit of two). These numbers must be stored in iNet and associated there with the worker's cellular battery. The following also apply:

- Using the DSX docking station, one company message can be added to the preset messages.
- The worker can access the messages in reply to an incoming message or to initiate messaging.
- Each message from a worker is only sent to the battery's preprogrammed, associated cell-phone numbers.

To indicate an *incoming* message, which can be up to 16 characters (including spaces) in length, the instrument will flash its blue light and display the message symbol (☰) in the status bar. The worker can view and optionally acknowledge or reply to an incoming message as shown below.

Home	Incoming message	Choose message	Send message
			
 	 	 	 
View message	Reply to message      Acknowledge message	Scroll list      Select highlighted option	Cancel message      Send message

To initiate messaging, repeatedly press the power button (⏻) to reach the *cellular battery* screen. The message symbol (☰) will display in the navigation bar. Press the button below the symbol to display the “choose message” list. Scroll through the list, then highlight and send the desired message.

## Man-down

An instrument's man-down functionality can be temporarily disabled or placed on standby status.

## Disabled

Man down functionality can be disabled when the instrument's site name is updated by an iAssign Beacon that is broadcasting a special site name. For example, a company cafeteria may have a Beacon set to this signal to temporarily prevent instruments at rest from causing man-down warnings or alarms. The Ventis Pro display screen will feature a symbol (✘) to indicate the man-down feature is not operational. To restore functionality, simultaneously press the power and enter buttons (⏻ and ⏹); otherwise, the functionality will self-restore after 60 minutes or when the instrument's site name is updated, whichever comes first.

## Standby

When the Standby Clip is in use, it serves to place man down on standby. The Ventis Pro display screen will feature a symbol to indicate standby status: man-down functionality is not operational (✘). When the Standby Clip is detached from the instrument, man-down functionality is restored within approximately 5 seconds.

# Alarms and Warnings At-a-glance

## Alarms

Alarms notify the instrument operator of danger.

The Ventis Pro Series instruments have alarms of four intensities, high, low, peer high, and LOW ALARM. Alarms are persistent. They turn off when the alarm-causing event is no longer detected, unless they are latched. A latched alarm can be turned off by pressing ⏻. LENS peer-alarm signals can be turned off by pressing ⏻; details will remain visible on the display screen.

When all alarm signals\* are on:

- The *high* alarm is bright red in color; it uses two different sounds and a vibration. It is fast-paced.
- The *low* alarm is similar to the high alarm but includes blue as well as bright red light. It is medium-paced.
- *Peer alarms* are similar to the low alarm but are slower in pace.

\*Signals (visual, audible, and vibration) vary based on instrument settings.

Information about gas alarms is presented in different formats on the display screen. In addition to the "readings" and "event type" formats, an instrument user may also see "alarm action" (instructional) or "full-screen" alarm messages. Sample display screens are shown below for instrument alarms and peer alarms.

Alarms (sample display screens for 100 ppm CO)

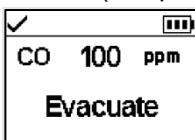

Alarm action format  
(Evacuate shown)

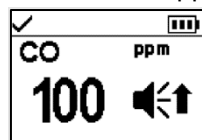

Full screen alarm format

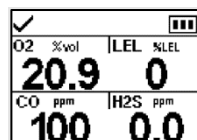

Readings

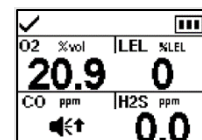

Event type



LENS peer alarms (sample display screens)

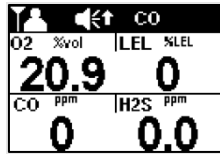

Peer alarm (panic shown)



Peer alarm (gas present, high shown)

 and  indicate the in-alarm instrument is a Ventis Pro or a Radius® BZ1 Area Monitor, respectively.

When an instrument is in alarm, its display will feature a symbol that indicates the event type. LENS peer alarms use the same or similar symbols; samples are shown below.

High alarm

Event

**OR, -OR**

Gas present (over-range event)



Gas present (high-alarm event)

**STEL**

STEL event

**ERROR  
408**

System error



Critical low battery



Man down; Peer man down

MAN DOWN



Panic; Peer panic

PANIC ALARM

Low alarm



Gas present (low-alarm event); Peer gas present (low-alarm event)

**TWA**

TWA event

## Warnings

Warnings notify the instrument operator of a condition that needs attention.

Warnings turn on and off repeatedly. The more urgent the warning, the shorter the time between on-off occurrences: a warning that repeats every two seconds is more urgent than a warning that repeats every thirty seconds. Warnings persist until the issue is resolved; however, the signals for the iNet Now connection-lost and gas-alert warnings can be temporarily turned off by pressing (Ⓢ).

When all signals\* are on, a warning appears as a short burst of red and blue light mixed with sound and vibration.

\*Signals (visual, audible, and vibration) vary based on instrument settings.

Sample display screens are shown below for instrument warnings and peer warnings.

Warnings (sample display screens)

Instrument warnings

Man-down warning



120-second pre-alarm countdown.

Gas-present alert

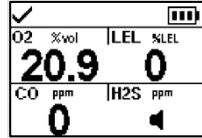

H<sub>2</sub>S gas-present alert.

Instrument issue

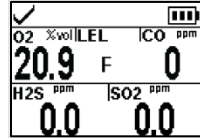

LEL sensor failure.

Maintenance required



Bump test due for CO and H<sub>2</sub>S.

Low battery

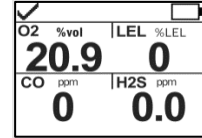

Other Warnings

iAssign warning

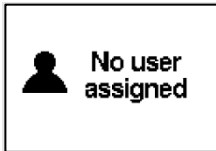

LENS Wireless warnings

Group lost

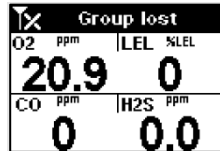

Peer lost

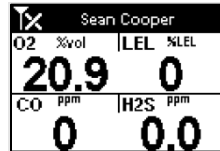

No peers



iNet Now connection lost





---

# Alarms, Warnings, and Notifications

Overview

Alarms

Warnings

Indicators

Failures and Errors

---

## Overview

This chapter provides in-depth information about alarms, warnings, and notifications; portions of this text appear in abbreviated form elsewhere within this product manual.

Alarms notify the instrument operator of danger.

Warnings notify of a condition that needs attention.

Indicators notify of a status (e.g., Standby Clip™ attached).

Take seriously all alarms, warnings, and indicators, and respond to each according to company policy.

## Alarms

Alarms notify instrument operators of danger. Alarm intensity is based on the event type and its source. Ventis Pro instrument have alarms of four intensities; from highest to lowest they are:



- High alarm
- Low alarm
- Peer high alarm (LENS Wireless)
- Peer low alarm (LENS Wireless)

When all signals\* are on, the following apply:

- The *high alarm* features only red light and is fast-paced.
- The *low alarm* is similar to the high alarm but includes blue as well as red light. It is medium-paced.
- *Peer alarms* are similar to the low alarm but are slower in pace.

\*Signals (visual, audible, and vibration) vary based on instrument settings.

Alarms are persistent: they turn off when the alarm-causing event is no longer detected; however, if the instrument's alarm latch setting is on, an alarm will remain on until the user presses  to turn it off. A peer

alarm can be acknowledged by pressing , which turns off alarm signals, but preserves details on the display; if two or more peer alarms are active, they will *all* be acknowledged with a single press of the enter button .

When the instrument has more than one active alarm (or active peer alarm), the display will cycle through messages for each event; however, when the instrument is in alarm, it will not display peer alarms.

Instrument alarm events are distinguished from one another through the use of symbols (see Table 6.1) that appear on the display screen. Peer events use the same or similar symbols within peer-alarm messages.

Table 6.1 Alarm events (list)













Alarm symbol	Alarm level	Alarm event	Description
Instrument events			
<b>OR, -OR</b>	High	Gas present (over-range)	The detected gas concentration is outside the sensor's measuring range.
	High	Gas present (high-alarm)	The detected gas concentration exceeds the high-alarm setpoint.
STEL	High	STEL	The cumulative measure of a detected gas exceeds the STEL setpoint.
	High	Man down	The instrument has been stationary for the set period of time. To turn off the alarm, press and hold  .
	High	Panic	The user has pressed the instrument's panic button and held it long enough (approximately 3 seconds) to turn on the panic alarm. To turn off the alarm, press and hold  .
<b>ERROR 408</b>	High	System	The instrument is in failure (error code 408 shown here) and is not operational.
	High	Critical low battery	The instrument has shut down and is not operational.
Access Denied	High	Proximity	The instrument has entered an iAssign® Beacon-restricted area where the Beacon's access level is higher than that of the current user's access level.
	Low	Gas present (low-alarm)	The detected gas concentration exceeds the low-alarm setpoint.
TWA	Low	TWA	The cumulative measure of detected gas exceeds the TWA setpoint.
LENS peer events			
	Peer high	Peer gas present (high-alarm)	For <i>any</i> peer alarm, turn off alarm signals by pressing and briefly holding  , the alarm message will remain on display in the status bar.
STEL	Peer high	Peer STEL	
	Peer high	Peer man down	
	Peer high	Peer panic	

Table 6.1 Alarm events (list)

Alarm symbol	Alarm level	Alarm event	Description
	Peer low	Peer gas present (low-alarm)	
TWA	Peer low	TWA	

See [Appendix E](#) for detailed audio and visual pattern.

For some instrument alarms, the display screen provides alarm details in multiple formats, which alternate during the event. For example, a high-alarm gas event has three possible display formats as described and shown below for an instrument that is in high alarm caused by the CO sensor reading, which is now at 100 ppm. A peer alarm caused by the same event is also featured below.

Display screen formats

Instrument alarms

Instruction

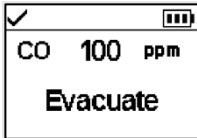

If the instrument is set to provide the user with instruction, the instruction format will be displayed (“Evacuate” shown here); otherwise, the full-screen alarm format will be shown.

Full-screen alarm

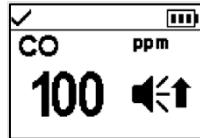

Event

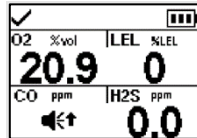

The symbol indicates the event type and identifies the in-alarm sensor.

Current readings are provided for all other installed sensors.

Readings

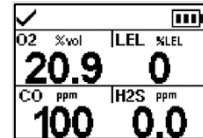

Provides the current reading for the in-alarm sensor and all other installed sensors.

LENS peer alarms

Event

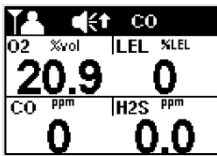

User

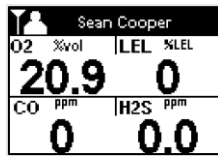

Sample display screens are reproduced below for each event that can cause an alarm. For any event that can feature multiple display formats, each format is shown here; they will alternate on the display screen during the alarm event.

Alarm level: High

Gas present, over-range alarm

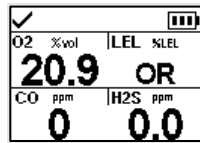
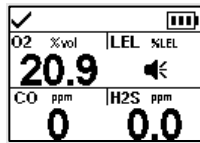
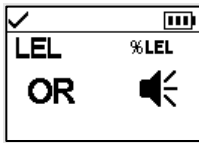

—

Gas present, high alarm

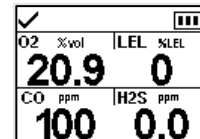
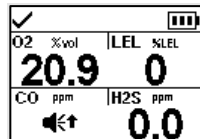
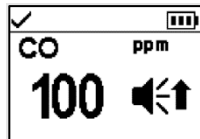
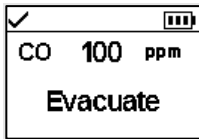

STEL alarm

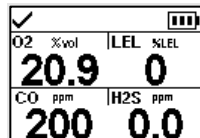
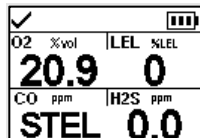
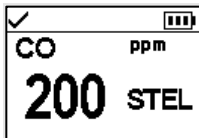

—

Critical low battery alarm



System alarm



Man-down alarm



Panic alarm



Alarm level: Low

Gas present, low alarm

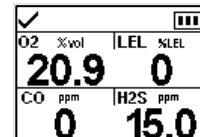
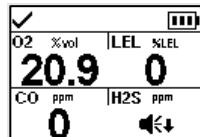
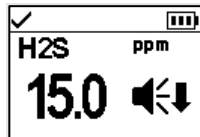
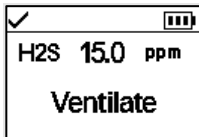

TWA alarm

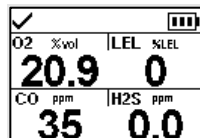
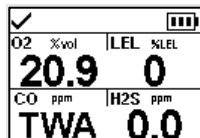
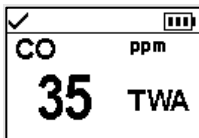

—

---

Alarm level: LENS peer high

Peer gas present, high alarm

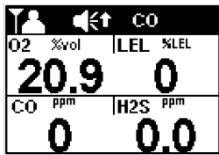

Peer STEL



Peer panic alarm



Peer man down



---

Alarm level: LENS peer low

Peer gas present, low alarm

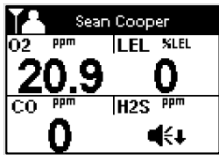

Peer TWA

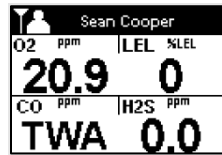



Figure 6.1 Alarm events (display screens)

---

## Warnings

Warnings turn on and off repeatedly. The more urgent the warning, the shorter the time between on-off occurrences: a warning that repeats every two seconds is more urgent than a warning that repeats every thirty seconds.

Warnings persist until the event is resolved; however, the iNet Now connection-lost warning and the gas-alert warning signal can be temporarily turned off by pressing the enter button . In some cases, an unresolved warning will cause an alarm. For example, if the man-down warning turns on and the instrument operator does not turn it off, the instrument and its signals will change from warning status to alarm status. Similarly, a low-battery warning that is not resolved will change to alarm status indicating a critical low-battery condition.

When all signal\* settings are on, warnings appear as a short burst of blue and red light mixed with sound and a vibration.

As with alarm events, warnings are distinguished from one another on the instrument display (see Table 6.2 below).













For LENS-group peer instruments, when an instrument can no longer connect with any instrument in its group, it is said to be "lost"—not within range of any peer-instrument. These warnings will occur:

- The instrument will activate its "group lost" warning to indicate to its operator that he or she is no longer connected to the group. It will continually attempt to rejoin the group for five minutes.
- The peer instruments will activate the "peer lost" warning, which will identify the name\*\* of the lost peer, the instrument user who has lost his or her connection to the group.

\*Signals (visual, audible, and vibration) vary based on instrument settings.

\*\*Requires valid user assignment.

Table 6.2 Warnings (list)

Symbol	Warning	Description
 MAN DOWN	Man-down	The instrument has not moved for the set period of time. To turn off the warning, move the instrument.
	Gas alert	A detected gas concentration may be approaching alarm levels. To turn off the warning, press and hold  .
	LEL-Low O <sub>2</sub>	LEL and O <sub>2</sub> sensors are installed and the concentration of O <sub>2</sub> is insufficient for LEL sensor functionality.
<b>F</b>	Sensor failure	One or more sensors is not working.
	Instrument maintenance required (bump test shown)	The instrument is in need of some form of maintenance (calibration, bump test, etc.).
	Low battery	The instrument's battery is low; replace or charge the battery.
 blinking	iNet Now or LENS group connection lost	The instrument's data is either not reaching the gateway or the gateway-to-iNet data upload is not occurring, so instrument data are <i>not</i> available to the users and message recipients of iNet Now. The instrument's connection-lost warning displays when all enabled connections are lost. Press  to acknowledge the warning and temporarily turn off the warning signals.
 not blinking	iNet Now or LENS group connection lost warning acknowledged	The instrument's connection-lost warning was user acknowledged; however, the connection remains lost. Instrument data are <i>not</i> available to the users and message recipients of iNet Now.
 Peer Name	Peer lost	A peer instrument has become disconnected from the LENS group without using the "Leave Group" option.
 Group Lost	Group lost	The user has <i>not</i> used the "Leave Group" option but has become disconnected from the LENS group; the instrument may be out of range from all other instruments in the group.
  NO PEERS NO PEERS	No peers	All equipment items have left the group

Display-screen reproductions are shown below for each condition that can cause a warning. For any warning that features multiple display formats, each format is shown; they will alternate on the display screen during the event.

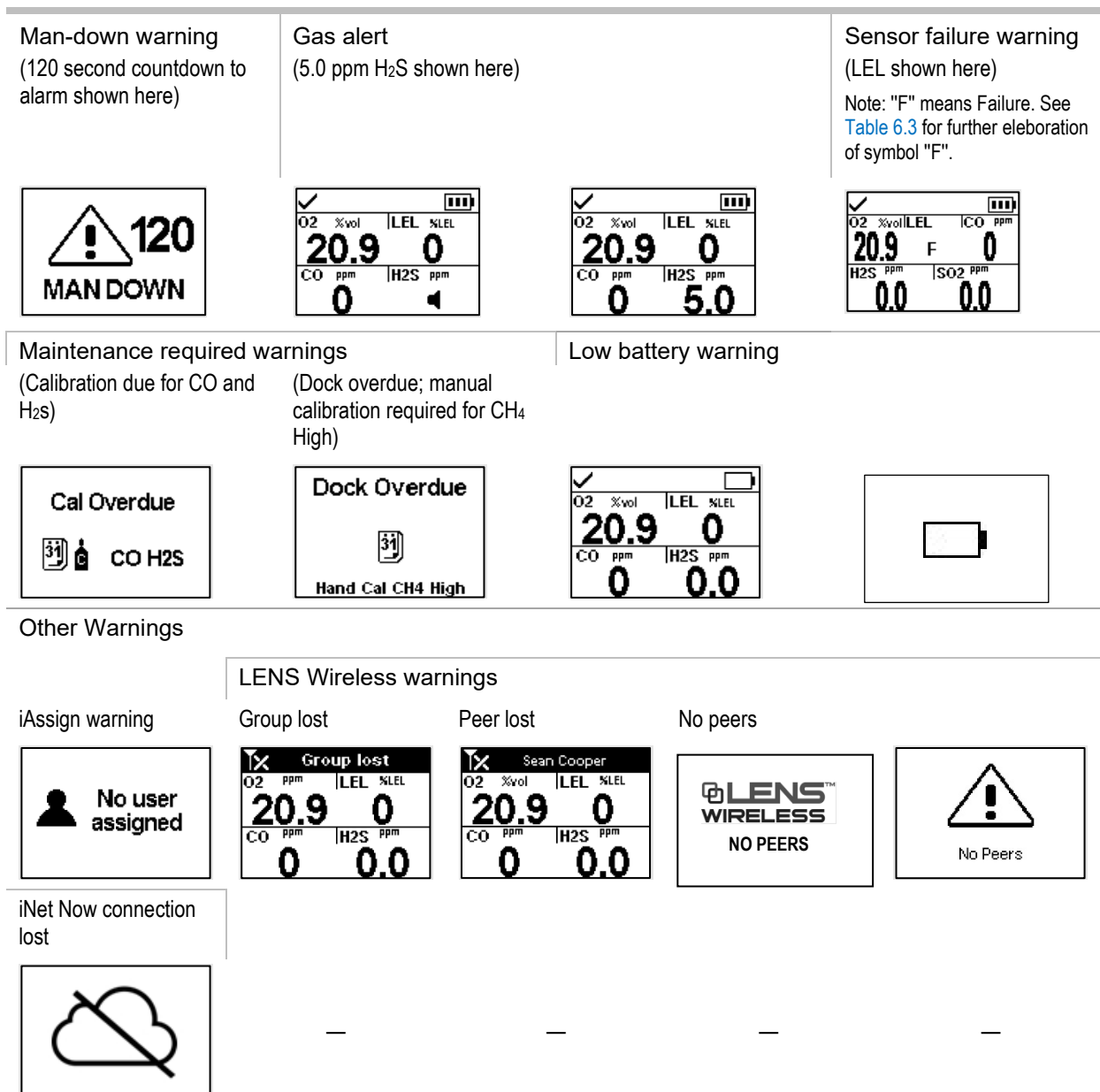



Figure 6.2 Warnings (display screens)

## Indicators

Most indicators turn on once, then off; only the confidence indicator persists, repeating every 90 seconds. If all signal\* settings are on, indicators will look and sound like this:

Indicator	Status	Color	Sound
iAssign update, messaging, calibration, or bump test	Success	Blue	
iAssign update, messaging, calibration, or bump test	Failure	Red	

\*Signals (visual, audible, and vibration) vary based on instrument settings.

## Failures and Errors

Some failures and errors are easily resolved by qualified personnel (see Table 6.3 below). For other errors or failures, contact Industrial Scientific for assistance.

Table 6.3 Failures and errors

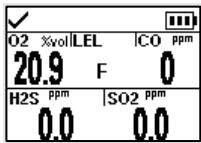
	<p>The sample display screen (left) indicates a sensor failure. The position of the “F” means it is the LEL sensor that is in failure. As noted below, different abbreviations or symbols are used to indicate other failures and errors.</p>	
Symbols	Cause	Recommended actions
<b>F</b> only	The sensor is in a general state of failure and is not operational.	Power off the instrument, then power it back on. If the failure persists, check the sensor for proper installation.
<b>ERR</b>	The sensor is installed in the wrong location.	Install the sensor in its correct location.
<b>⊗</b>	The CO <sub>2</sub> or O <sub>2</sub> sensor is installed in the wrong location.	Install the sensor in its correct location.
<b>∅F</b>	The sensor failed the zero process.	Repeat the zero process.
<b>BUMP</b> and <b>F</b>	The sensor failed bump testing.	Calibrate the instrument, then complete a bump test.
<b>CAL</b> and <b>F</b>	The sensor failed calibration.	<p>Calibration results indicate the sensor’s span reserve percentages. When that value is less than 50%, the sensor will not pass calibration and is due for replacement. If the span reserve percentage indicates the sensor is greater than 50% check for the following possible causes for the failure.</p> <ul style="list-style-type: none"> <li>• Ensure the calibration cup is compatible with the instrument and is correctly and securely placed on the instrument.</li> <li>• Check the tubing for splits, blockages, or damage.</li> <li>• Ensure the tubing is secured to the calibration cup and the cylinder’s regulator.</li> <li>• Ensure the cylinder is not empty and contains the required gas concentrations.</li> </ul> <p>If desired, repeat the calibration process.</p>
<b>!</b> and gas reading	A sensor that was operating in DualSense has failed.	The remaining sensor is operating as a single sensor. Respond according to company safety policy.

When a failure is caused by conditions other than those listed above, an error code will display. Some indicate a possible installation error or compatibility issue; qualified personnel may attempt to resolve these and other errors (see Table 6.4 below). For all other error codes, contact Industrial Scientific for assistance.

Table 6.4 Critical errors

<b>ERROR 408</b>	The display screen reproduction shown here (left) is an example of a critical error. The instrument is put into a state of failure until the error is resolved. The 408 code indicates a specific issue; different codes are used to indicate various failures.	
Error code	Cause	Possible resolution
406	A sensor is installed in the wrong location.	Check the sensor type and install it in its correct location.
408	No sensors are installed or the installed sensors are not detected by the instrument.	Check the installed sensor for proper installation, correct location, and compatibility.
490	A sensor may have become disconnected from the circuit board.	Check for a loose or dislodged sensor, and for damage to the sensor pins and their board receptors.
470	An incompatible battery is installed.	Check the installed battery's part number for compatibility; install a compatible battery if needed.



---

# Maintenance

## Guidelines

Zero, Calibration, Bump Test, Response and Recovery Time Testing

Supplies and Preparation

Instruction

---

## Guidelines

This chapter provides instructions for manually completing these utilities: bump testing, zeroing, calibration, response time testing, and recovery time testing. These procedures can also be completed using compatible Industrial Scientific docking stations and accessories that are supported by iNet, DSSAC, or Accessory Software. Elsewhere in this product manual (Chapter 1) are the definitions and recommended practices for each procedure.

Use these guidelines to prepare for manually completing a zero, calibration, bump test, response time testing, or recovery time testing.

- Work in an area known to be nonhazardous.
- Use certified Industrial Scientific calibration gas.
- Choose calibration gas cylinders that are suitable for the installed sensors and their calibration gas settings, and for the instrument's process-type setting ("quick" vs. "standard").

When instruments are set to the "quick" process type, one application of gas is permitted. This setting is usually the choice for applications in which one calibration gas cylinder contains all the required gases.

When set to the "standard" process type, it is often because more than one gas cylinder is required to calibrate or bump test all the installed sensor types. For example, a cylinder that contains more than one gas may be suitable for three of the installed sensors while the fourth sensor may require a gas that is not contained in that cylinder. During the standard process, the instrument will prompt its user for the application of each gas and, between gases, will allow time for a change of cylinders.

## Zero, Calibration, Bump Test, Response and Recovery Time Testing

Whether bump testing calibrating manually or testing response and recovery time, the basic steps are:

- Gather the needed supplies.
- Prepare the gas cylinder for use.
- Access the utility on the instrument.

- Connect the calibration cup to the instrument.
- Turn on the gas cylinder.
- View the results.
- Remove the calibration cup.
- *Turn off the gas cylinder.*

## Supplies and Preparation

Use Figure 7.1 as a guide to gathering supplies and preparing the calibration gas cylinders.

---

### Supplies

- Calibration gas cylinder or cylinders
  - Positive flow regulator suitable for the calibration gas cylinders
  - Calibration cup (shipped with the instrument)
  - Calibration tubing (shipped with the instrument)
  - Stopwatch
- 

### Preparation



Holding the regulator, turn the calibration gas cylinder in a clockwise direction to tighten.

If a change in cylinders will be needed for a standard calibration or bump test, this preparation step can be completed for each cylinder.



Connect either end of the calibration tubing to the regulator's nipple.



Connect the other end of the tubing to the calibration cup.

*Note:* The maximum calibration flow rate is 500 ml/min (30 l/hr).

Figure 7.1 Maintenance supplies and preparation

---

# Instruction

Figure 7.2.A through 7.2.E provide maintenance instruction in this order: zeroing, calibration, bump testing, response time testing, and recovery time testing. The standard process is shown for calibration and the quick process is shown for bump testing. When a process varies from those shown below, the instrument will supply instruction on its display screen.

## Zeroing







Zero utility	Zero Progress	Zero Results
		
 	 	<p>When the zero is completed, the instrument will emit an audible indicator and display results as follows:</p> <p>✓ Passed</p> <p>✗ Failed</p> <p>If any sensor failed, press  to access the zero utility and repeat the zero process.</p>
<p>Cancel      Start zero process</p>		

Figure 7.2.A Zeroing instruction

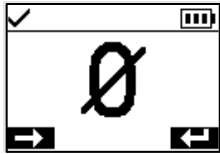
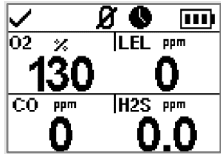
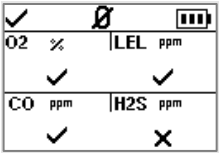
## Calibration (standard process shown)







Place the prepared calibration cup over the instrument case top.

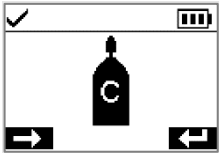
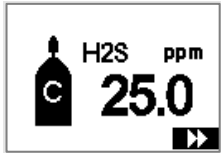

Press down to secure the cup in place; a click will sound.



Visually inspect the calibration cup to ensure its edges along the top and sides align with the instrument case top edges.

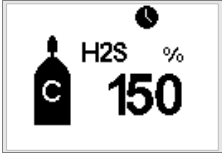
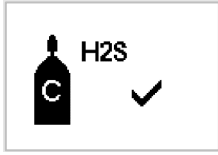

Calibration utility	Calibration apply gas	
		
 	 	<p>This screen remains active for up to 5 minutes as the unit awaits the application of calibration gas.</p> <p>To cancel calibration, press .</p> <p>Apply calibration gas of the type and concentration stated on the instrument's display screen. To start the flow of gas, turn the regulator's knob in a counterclockwise direction.</p>
<p>Cancel calibration      Start calibration</p>	<p>If desired, skip calibration for the displayed gas</p>	

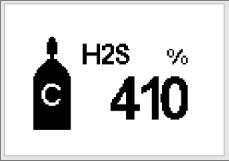
Calibration progress	Calibration results
	
<p>—</p> <p></p> <p>Cancel calibration</p>	<p>✓ Passed</p> <p>✗ Failed</p>
<p>When the calibration is completed, the instrument will display a calibration results of passed or failed, along with the sensor's span reserve percentage.</p> <p><i>Note:</i> If the sufficient calibration gas value isn't reached in five minutes, the instrument will fail calibration.</p>	 <p>The span reserve percentage is an indicator of the sensor's remaining life. When that value is less than 50%, the sensor will no longer pass calibration.</p>

After the first sensor is calibrated and the results displayed, the instrument will activate the calibration process for the next gas type starting with the "Apply gas" request. The instrument will wait a few minutes to receive the requested calibration gas. This is the opportunity to change cylinders if needed, then continue the calibration process (in the same manner as described above for H<sub>2</sub>S) until all calibration gases have been applied.

After the installed sensors have been calibrated (or skipped), the instrument's display screen will state the calibration results for all installed sensors.















All-sensor calibration results	End																							
<p>✓ Passed</p> <p>✗ Failed</p> <p>▶▶ Skipped</p> <p>— Not relevant to the procedure.</p>	<table border="1"> <tr> <td>✓</td> <td></td> <td></td> </tr> <tr> <td>O<sub>2</sub> ✗</td> <td>LEL</td> <td></td> </tr> <tr> <td>CO</td> <td>H<sub>2</sub>S ✗</td> <td>▶▶</td> </tr> </table> <table border="1"> <tr> <td>✓</td> <td></td> <td></td> </tr> <tr> <td>O<sub>2</sub> ✗</td> <td>LEL</td> <td></td> </tr> <tr> <td>CO</td> <td>H<sub>2</sub>S</td> <td>✓</td> </tr> <tr> <td>✓</td> <td></td> <td>✓</td> </tr> </table>	✓			O <sub>2</sub> ✗	LEL		CO	H <sub>2</sub> S ✗	▶▶	✓			O <sub>2</sub> ✗	LEL		CO	H <sub>2</sub> S	✓	✓		✓	 <p>Remove the calibration cup: lift up from the cup's tabs.</p>	 <p>Stop the flow of gas: turn the regulator knob in a clockwise direction and tighten.</p>
✓																								
O <sub>2</sub> ✗	LEL																							
CO	H <sub>2</sub> S ✗	▶▶																						
✓																								
O <sub>2</sub> ✗	LEL																							
CO	H <sub>2</sub> S	✓																						
✓		✓																						
<p> Use Table 7.1 as a guide to help determine the probable cause for calibration failure and find recommendations for resolution.</p>																								

Figure 7.2.B Calibration instruction

**Bump testing (quick process shown)**

Place the prepared calibration cup over the instrument case top. Press down to secure the cup in place; a click will sound.





Visually inspect the calibration cup to ensure its edges along the top and sides align with the instrument case top edges.



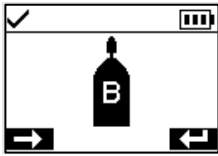

**Bump test utility**

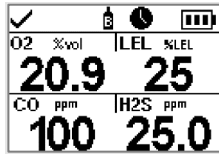

 Cancel bump test  
 Start bump test

**Apply gas**



This screen remains active for up to 5 minutes as the unit awaits the application of calibration gas. To cancel calibration, press .



Apply calibration gases of the type and concentration stated on the instrument's display screen: turn the cylinder's regulator knob in a counterclockwise direction.

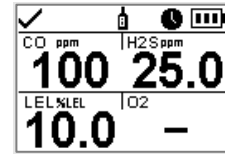

**Bump test progress**



 Cancel bump test

**All-sensor bump test results**

✓		
O2	LEL	
✓	✓	
CO	H2S	
✓	✓	

✓		
O2 ppm	LEL ppm	
X	X	
CO ppm	H2S ppm	
X	X	

After the bump test is completed, summary results are shown. If any sensors fail the bump test, the calibration required warning will turn on. Complete a calibration for any failed sensor, then repeat the bump test.

- ✓ Passed
- X Failed
- ▶▶ Skipped
- Not relevant to the procedure

**End**



Remove the calibration cup: lift up from the cup's tabs.



*Stop the flow of gas:* turn the regulator knob in a clockwise direction and tighten.

**Figure 7.2.C Bump testing instruction**

Note: For further details on bump testing, see [bump test](#).

**Response time testing (standard process shown)**

Place the prepared calibration cup over the instrument case top.

Press down to secure the cup in place; a click will sound.



Visually inspect the calibration cup to ensure its edges along the top and sides align with the instrument case top edges.



**Apply gas**

To start the flow of gas, turn the regulator's knob in a counterclockwise direction.



**Gas response**

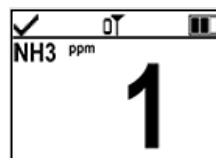

Gas response on the normal reading screen  
Start a timer when the display shows a response to the calibration gas.

*Note:* Response time is to be tested at the normal reading screen.

**Measuring response time**

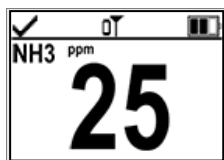

Reading at 50% of calibration gas

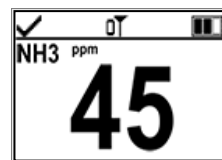

Reading at 90% of calibration gas

Stop the timer when the displayed reading reaches 50% or 90% of the calibration gas concentration. If the time to reach the 50% or 90% times specified in the sensor specifications is greater than 30%, the sensor should be replaced.

**End**



*Stop the flow of gas:* turn the regulator knob in a clockwise direction and tighten it.



Remove the calibration cup: lift up from the cup's tabs.

**Figure 7.2.D Response time testing**

### Recovery time testing (standard process shown)

Place the prepared calibration cup over the instrument case top.

Press down to secure the cup in place; a click will sound.



Visually inspect the calibration cup to ensure its edges along the top and sides align with the instrument case top edges.



#### Apply gas

To start the flow of gas, turn the regulator's knob in a counterclockwise direction.



#### Gas response

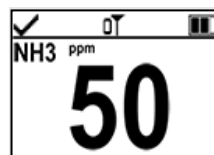

Allow the gas reading to stabilize before proceeding with the next step.

*Note:* Recovery time is to be tested at the normal reading screen.

#### Stop Gas



*Stop the flow of gas:* turn the regulator knob in a clockwise direction and tighten it.



Remove the calibration cup: lift up from the cup's tabs.

#### Measuring recovery time

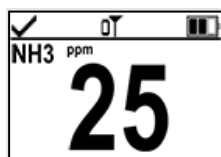

Reading at 50% of calibration gas

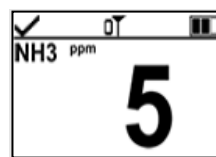

Reading at 10% of calibration gas

Stop the timer when the reading reaches 50% or 10% of the calibration gas concentration. If the time to reach the 50% or 10% times specified in the sensor specifications is greater than 30%, the sensor should be replaced.

Figure 7.2.E Recovery time testing

Table 7.1 Calibration failure: possible causes and recommendations

Possible causes for calibration failure	Recommendations
The sensor's span reserve percentage is less than 50%.	The sensor is due for replacement.
The gas cylinder did not contain the calibration gas in the concentration needed.	Repeat the calibration with a suitable gas cylinder.
When all sensors fail, this may indicate the calibration gas did not reach the sensors.	<p>Check for the following.</p> <ul style="list-style-type: none"> <li>• Ensure the calibration cup is compatible with the instrument.</li> <li>• Ensure the calibration cup is correctly and securely placed on the instrument.</li> <li>• Check the tubing for splits, blockages, or damage.</li> <li>• Ensure the tubing is secured to the calibration cup and the cylinder's regulator.</li> <li>• Ensure the cylinder is not empty and contains the required gas concentrations.</li> <li>• Be sure the cylinder is turned on when the apply-gas screen displays and remains on until the calibration is completed.</li> </ul> <p>Repeat the calibration.</p>

---

# Service and Warranty

Service

Warranty

---

## Service

### Guidelines

Service tasks that can be completed by Industrial Scientific customers are described in this Product Manual. Table 8.1 indicates which parts and components are customer replaceable. All other service tasks should be performed only by Industrial Scientific or an authorized service center.

- Service tasks should be performed only by qualified personnel.
- Use only approved Industrial Scientific parts and accessories.
- Perform service tasks in a nonhazardous location.
- Work on a nonconductive surface in a well-lit area.
- Wear grounding straps to prevent electrostatic discharge (ESD), which can cause damage to the instrument's electronics.
- Be sure to turn off the instrument before (1) servicing the unit or (2) replacing the battery.
- Before removing the instrument's battery, dock the instrument to synchronize it with iNet Control, Accessory Software, or DSSAC.

Use care when working with the adhesive-backed filters and gaskets.

- Be careful not to pierce or tear these items.
- When using tweezers, apply gentle pressure.
- Once the adhesive touches a surface, any attempt to remove or reposition the item may cause it damage.

Use care when working with sensors and water barriers.

- Do not touch the sensors' membranes as this can contaminate the items.
- Do not separate the sensor from its membrane.
- Do not damage or tear the membranes or water barriers.

### Supplies

- ✓ T10 torx screwdriver
- ✓ Needle-nose tweezers (for barrier and filter replacement)

## Instruction

Figures 8.1 and 8.2 provide disassembled views of the instrument and its pump module, respectively, identifying their parts and components. Use Table 8.1 to determine which items are customer replaceable and identify their part names and part numbers.

---

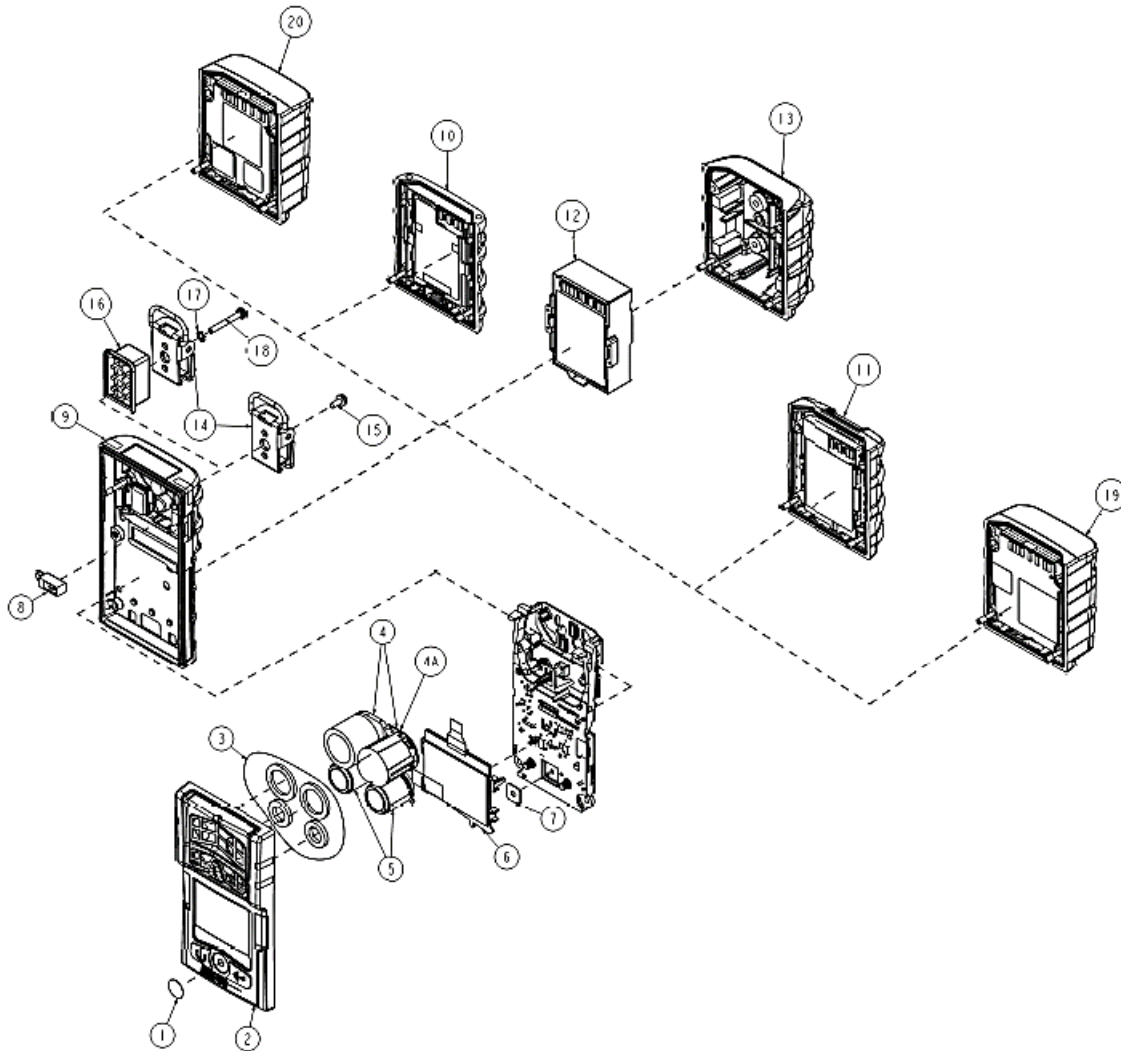

Figure 8.1 Instrument diagram

---

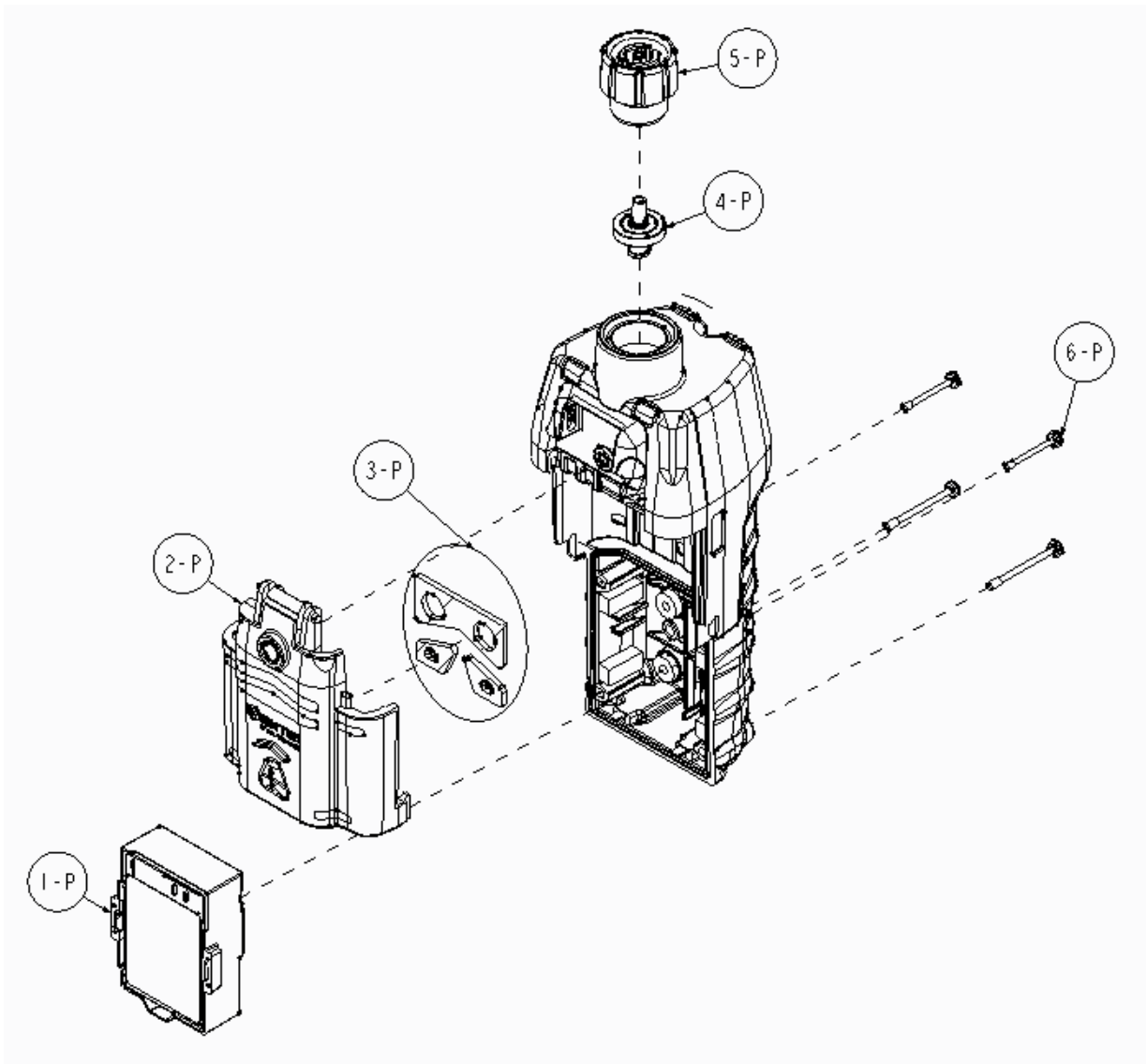

Figure 8.2 Pump module diagram

Table 8.1 Instrument and pump module parts list

Diagram number	Part name	Customer replaceable	Part number	Notes
<b>Instrument</b>				
1	Dust barrier kit	Yes	18109613	Includes ten speaker dust barriers.
2 (includes 1 and 3)	Case top assembly	Yes	17156049-XY	Assembly includes case top, speaker dust barrier, and sensor water barriers. X indicates case-cover color, where 0 = Black and 1 = Orange. Y indicates name plate, where 1 = Ventis Pro4 and 2 = Ventis Pro5.
3	Sensor water barrier kit	Yes	18109436	Includes one water barrier for each sensor port.
4, 4a, and 5	For compatibility, permitted installation locations, and individual sensor specifications, see <a href="#">Sensors and installation locations</a> and <a href="#">Table 2.7 Sensor specifications</a> .			
	Ammonia (NH <sub>3</sub> )	Yes	17155306-6	Ventis Pro5 only.
	Carbon Dioxide/LEL (Propane), IR (CO <sub>2</sub> /LEL)	Yes	17155304-U 17155304-UA	Ventis Pro5 only. The sensor is certified for use according to FTZÚ 18 E 0010 or FTZÚ 18 ATEX 0083 or IECEx FTZU 21.001 for gas performance.
	Carbon Dioxide/Methane (CO <sub>2</sub> /CH <sub>4</sub> )	Yes	17155304-V	Ventis Pro5 only.
	Carbon Monoxide (CO)	Yes	17155306-1 17155306-1A	— The sensor is certified for use according to FTZÚ 18 E 0010 or FTZÚ 18 ATEX 0083 or IECEx FTZU 21.001 for gas performance.
	Carbon Monoxide High Range (CO)	Yes	17155306-H	Ventis Pro5 only.
	Carbon Monoxide/Hydrogen Sulfide (CO/H <sub>2</sub> S)	Yes	17155304-J	Ventis Pro5 only.
	Carbon Monoxide/Hydrogen Sulfide (CO/H <sub>2</sub> S)	Yes	17155306-J	Ventis Pro5 only.
	Carbon Monoxide with low Hydrogen cross-sensitivity (CO/H <sub>2</sub> Low)	Yes	17155306-G	—
	Chlorine (Cl <sub>2</sub> )	Yes	17155306-7	Ventis Pro5 only.
	Hydrogen (H <sub>2</sub> )	Yes	17155304-C	Ventis Pro5 only.

Table 8.1 Instrument and pump module parts list

Diagram number	Part name	Customer replaceable	Part number	Notes
	Hydrocarbon, IR (Propane)	Yes	17155304-P	—
	Hydrocarbon, IR (Propane)	Yes	17155304-T	Ventis Pro5 only.
	Hydrogen Cyanide (HCN)	Yes	17155306-B	—
	Hydrogen Sulfide (H <sub>2</sub> S)	Yes	17155306-2	—
			17155306-2A	The sensor is certified for use according to FTZÚ 18 E 0010 or FTZÚ 18 ATEX 0083 or IECEx FTZU 21.001 for gas performance.
	Hydrogen Sulfide (H <sub>2</sub> S)	Yes	17155304-2	—
	LEL (Methane)	Yes	17155304-L	—
			17155304-LA	The sensor is certified for use according to FTZÚ 18 E 0010 or FTZÚ 18 ATEX 0083 or IECEx FTZU 21.001 for gas performance.
	LEL (Pentane)	Yes	17155304-K	—
	Methane, 0-5% vol.	Yes	17155304-M	—
	Methane, IR, (CH <sub>4</sub> )	Yes	17155304-N	Ventis Pro5 only.
	Methane, IR, (CH <sub>4</sub> )	Yes	17155304-S	—
	Nitrogen Dioxide (NO <sub>2</sub> )	Yes	17155306-4	—
	Oxygen (O <sub>2</sub> )	Yes	17155304-3	—
	Oxygen, Long-life (O <sub>2</sub> )	Yes	17155304-Y	—
			17155304-YA	The sensor is certified for use according to FTZÚ 18 E 0010 or FTZÚ 18 ATEX 0083 or IECEx FTZU 21.001 for gas performance.
	Oxygen, Long-life (O <sub>2</sub> )	Yes	17155306-Y	—
	Phosphine (PH <sub>3</sub> )	Yes	17155306-9	—
	Sulfur Dioxide (SO <sub>2</sub> )	Yes	17155306-5	—
	Volatile Organic Compound (VOC) PID	Yes	17155304-R	Ventis Pro5 only.
6	LCD assembly	No*	—	—
7	Audible alarm speaker	No*	—	—
8	Vibration alarm motor	Yes	17120080	—
9	Case bottom	No*	—	Screw torque: .39 newton m (55 ounce-force inch)
	Calibration cup	Yes	17152455	—

Table 8.1 Instrument and pump module parts list

Diagram number	Part name	Customer replaceable	Part number	Notes
<b>Rechargeable Lithium-ion batteries</b>				
20	Ventis Pro Cellular Battery	No	See Table 8.2	Ventis Pro5 only. Screw torque: 0.39 newton m (55 ounce-force inch)
19	Ventis Pro Wi-fi Battery	Yes	See Table 8. 2	Screw torque: 0.39 newton m (55 ounce-force inch) **The Ventis standard battery has been discontinued and is no longer available for ordering. The recommended alternative is the Ventis slim extended battery.
10	Ventis Standard Battery**	Yes		
11	Ventis Slim Extended Battery	Yes		
12	Ventis Extended Run-time Battery	Yes		
13	Battery cover (for use with Ventis Extended Run-time battery)	Yes		
14	Suspender clip	Yes	17120528	—
15	Screw with locking washer	Yes	17158205	Torque: .88 newton m (125 ounce-force inch)
16	Suspender clip spacer	Yes	17152506	Use with deep-dimension batteries (e.g., wi-fi battery)
17	Locking washer	Yes	17153137	—
18	Screw (for use with suspender clip spacer)	Yes	17158281	Torque: .88 newton m (125 ounce-force inch)
<b>Pump</b>				
1P - 6P	Pump module	Yes	VPP-ABCD	A indicates battery, where 0 = no battery and 2 = extended range rechargeable lithium-ion battery B indicates color, where 0 = black and 1 = orange C indicates approvals, where 1=UL and CSA, 2 = ATEX and IECEX, 3 = MSHA, and 9=INMETRO D indicates language, where 1 = English, 2 = French, 3 = Spanish, 4 = German, C=Chinese, and -7 = Brazilian Portuguese
Pump module parts				
1P	Ventis Extended Run-time Battery	Yes	See Table 8.2	Screw torque: 0.39 newton m (55 ounce-force inch)
2P (includes 3P)	Door assembly	Yes	17156945-X	X indicates color, where 0 = black and 1 = orange.

Table 8.1 Instrument and pump module parts list

Diagram number	Part name	Customer replaceable	Part number	Notes
3P	Gaskets	No*	—	—
4P	Internal filter	Yes	17058157	—
5P	Inlet cap	Yes	17129909	—

\*For items that are *not* customer replaceable, contact Industrial Scientific or an authorized service center.

## Battery parts

The base part number that appears on the *label* of a Ventis battery item uses an eight-digit numeric format (XXXXXXXX). The corresponding *orderable* part numbers use the four-letter base reference "VTSB", which is followed by a three-character suffix. The first suffix character is a number that designates the battery type; the second and third are used to indicate color and approval options, respectively. For example, as shown below in Table 8.2, a rechargeable slim extended lithium-ion battery kit that is black and has a UL approval would have an orderable part number of VTSB-401 and its label would state a part number of 17157350-01.

Table 8.2 Battery parts list

Diagram number	Rechargeable Lithium-ion batteries	Part numbers		Options <sup>a</sup> (X and Y)
		Label	Orderable kit	
20	Ventis Pro Cellular Battery	17159021-XY	Not sold separately	
19	Ventis Pro Wi-fi Battery	17159022-XY	VTSB-AXY	X indicates color: 0 for black (battery cover is only available in black)  Y indicates approvals: 1 for UL, CSA, ATEX, and IECEx; 2 for MSHA; 3 for China EX; 4 for ANZEx; and 5 for INMETRO
10	Ventis Standard Battery <sup>b</sup>	17134453-XY	(Discontinued)	
11	Ventis Slim Extended Battery	17157350-XY	VTSB-4XY	
12 and 13	Ventis Extended Run-time Battery (includes battery and cover)	17148313-Y (battery) 17151184-XY (cover)	VTSB-2XY (kit) <sup>c</sup>	

<sup>a</sup>Color and approval options may vary for each battery item. For more information, contact Industrial Scientific or an authorized distributor of its products.

<sup>b</sup>The Ventis standard battery has been discontinued and is no longer available for ordering. The recommended alternative is the Ventis slim extended battery.

<sup>c</sup>The battery and cover may be ordered separately using these part numbers 17148313-Y (battery) 17151184-XY (cover).



Power off the instrument before disassembling it or performing any service task.

### Pump installation



Unscrew and remove the belt clip. Store the clip, screw, and washer for future use.



Unscrew, lift, and remove the battery from the diffusion instrument; store it for future use.



Loosen the pump door screw.



Slide the pump door down; lift it to open.



Install a compatible extended range battery—label side up—into the lower receptacle of the pump case.



Place the instrument in the pump case; tighten the four torx screws on the back of the pump.



Lower the pump door. Slide it into its fully closed, clicked-shut position.



Tighten the pump door screw.

### Pump door replacement



Loosen the pump door screw.  
Slide the pump door down; lift it to open.

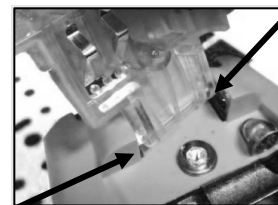

The door is hinged to the pump module with two pegs that slide into grooves. Angle the door so that one peg moves to the bottom of its groove and the other moves the top of its groove. Lift the door to remove it.

Install the new door in the same manner the door was removed.



Lower the pump door. Slide it into its fully closed, clicked-shut position. Tighten the pump door screw.

---

## Pump cap and internal filter replacement

*Important* – Power off the instrument prior to performing this service task.



To unscrew and remove the pump cap, turn it in a counterclockwise direction.

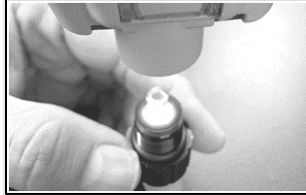

Invert the instrument. Remove the internal filter from the inlet barrel.



Insert the replacement filter in the filter cap (filter P/N 17058157 shown).

*Note:* Never operate the pump *without* the internal filter.

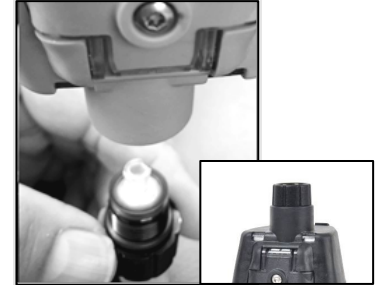

Invert the instrument. Place the new internal filter in the inlet barrel of the instrument.

Secure the pump cap to the inlet barrel: turn the cap in a clockwise direction to tighten.

Inspect the inlet barrel and sealing O-rings in the instrument and filter cap. Ensure the inlet barrel is clean and that both O-rings are in place and free of damage.

Inspect the filter cap inlet and inlet barrel for dirt, debris or liquid. Remove any dirt, debris, or liquid by blowing air through the cap or wiping gently with a clean, lint-free cloth.

---

**WARNING:** Explosion hazard. Only replace batteries in *nonhazardous* locations.

## Battery replacement

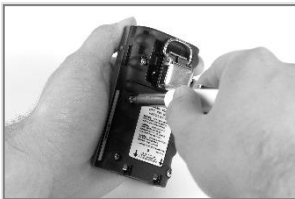

Using a torx screwdriver, loosen all four screws from the battery (left) or the battery cover (right).

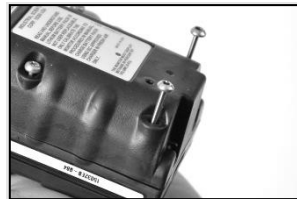

Lift the battery (left) or battery cover and battery (right) away from the instrument.



*Note:* If the instrument is without a battery for more than 40 minutes, the instrument date and time settings will be deleted. The next time the instrument is powered on, it will prompt its operator to set the date and time to support data-log integrity; this can be done manually or by docking the instrument.



To install a two-item battery, first place the battery in the battery cover. When placed correctly, the battery's label will show.

Next, align the battery cover with the instrument.



To install a single-part battery, align it with the instrument.

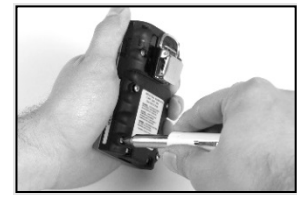

Using a torx screwdriver, tighten each of the four screws to secure the battery (shown) or battery cover to the instrument.

Refer to Table 8.1 for torque value.

---

## Garment clip replacement

### Garment clip only (use with standard and slim extended batteries)

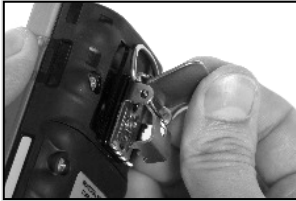

Lift the clip's cover.

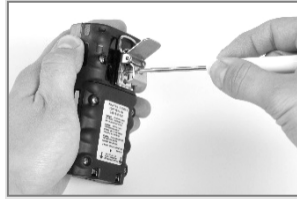

To remove the clip, use a torx screwdriver to access the clip's screw. Turn counterclockwise to loosen the screw.

Remove the screw, washer, and clip; set aside or store for future use.



To attach the clip, put the washer onto the screw and place the screw in the clip's middle hole.

Turn the screw clockwise to tighten; refer to Table 8.1 for torque value.

---

### Garment clip with spacer (use with deep-dimension batteries)

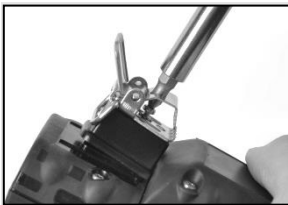

To remove the clip, use a torx screwdriver to access the clip's screw. Turn counterclockwise to loosen the screw.

Remove the washer, screw, clip, and spacer; set aside or store for future use.



To attach the clip and spacer, cover the case bottom's platform with the spacer.

Put the washer onto the screw and place the screw in the clip's middle hole.

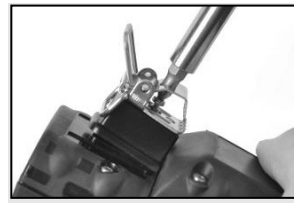

Guide the screw into the spacer's hole and into the instrument case bottom.

Turn clockwise to tighten; refer to Table 8.1 for torque value.

---

## Speaker dust barrier replacement

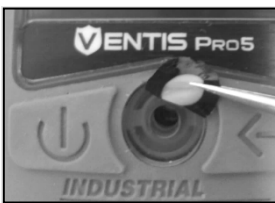

Using a finger or needle-nose tweezers, peel off the dust barrier and discard.

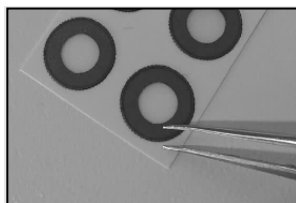

Place the barrier sheet on the work surface.

Scrape lightly across the paper to the barrier's edge. Gently lift to expose a portion of its adhesive back. Peel the barrier from the sheet.



Guide the new barrier—adhesive side down—onto the case top. Press and hold to support adhesion.



---

## Instrument disassembly

Instrument disassembly and reassembly is required for the service tasks described below, sensor water barrier replacement and sensor replacement. Optionally charge the instrument after reassembly.



Using a torx screwdriver, loosen all four captive screws on the battery.



Lift the battery away from the instrument.



Using a torx screwdriver, loosen the case bottom's remaining two screws.



Hold the case bottom near the upper screws. Lift the case top slightly to separate it from the case bottom.

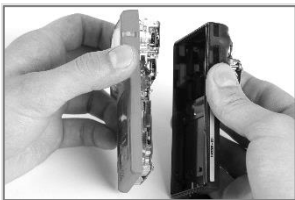

Continue to lift the case top straight up to remove it.



Near the top of the circuit board assembly, hold the plastic sides that border the sensors. Gently lift the circuit board assembly straight up and away to separate it from the case top.

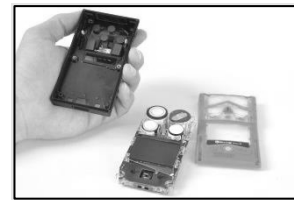

---

## Sensor water-barrier replacement



Inside the case top, grip the sensor water barrier with the needle-nose tweezers. Peel to remove.

Remove any remnants of the adhesive or water barrier.

Clear away any dirt, dust, or debris.

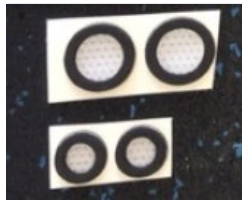

Place the water-barrier sheets on the work surface.

Using the tweezers, scrape lightly across the paper to the barrier's edge; gently lift to expose a portion of the adhesive back.

Grip the barrier lightly with the tweezers and peel it from the packet.



Guide the new water barrier—adhesive side down—into the case top.

For proper placement, take care to ensure the barrier edge meets the inner edge of the case top's sensor opening.

Using care not to touch the filter's white membrane, press on the filter edge to support adhesion.

---

## Sensor setup and replacement

---

### Sensor setup

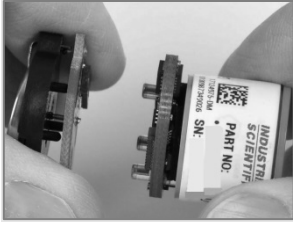

If a battery is attached to a sensor, separate the battery from the sensor where the two circuit boards meet. Dispose of the battery according to company policy.

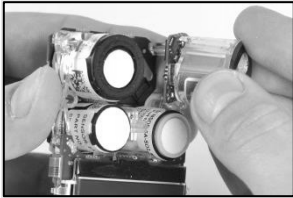

Position the new sensor to align its connectors with their receptacles on the instrument's circuit board assembly.

### Sensor replacement (LEL sensor shown)

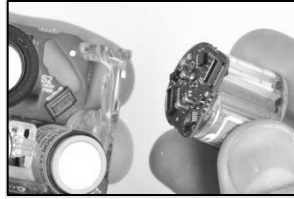

Hold the sides of the sensor firmly then pull it straight up and away from the instrument.

Some sensors, such as the LEL sensor shown here, include a small circuit board that should detach from the instrument board when the sensor is removed. If it does not detach, remove the sensor's board from the instrument board.

Store the sensor for future use or dispose of it according to company policy.

*Note:* When two sensors of the same type are operating on DualSense, replace both sensors at the same time.

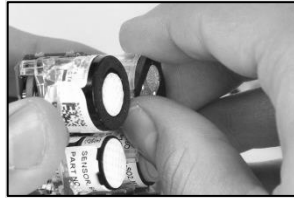
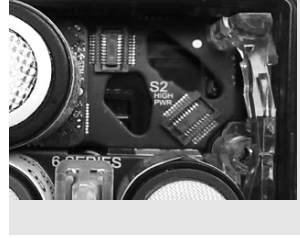

Secure the sensor in place by applying gentle pressure to the sides of the sensor case. *Do not touch the sensor's membrane.*

A slight connection impact can be felt when the sensor is secured into place.

*Note:* After reassembling the instrument, calibrate for any newly installed sensors.

---

## Instrument assembly and charging

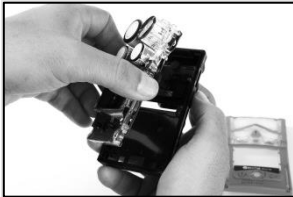

Near the top of circuit board assembly, hold the plastic sides that border the sensors.

Place the circuit board assembly into the instrument's case bottom.

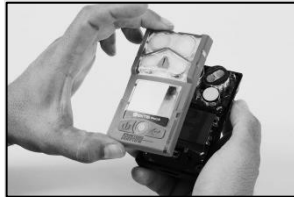

Lower the case top assembly onto the case bottom.



Press to secure the case top to the case bottom.



Using a torx screwdriver, tighten the top two screws. See Table 8.1 for torque value.



Place the battery against the case bottom.

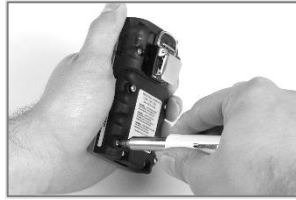

Using a torx screwdriver, tighten the screws. See Table 8.1 for torque value.

### Charging

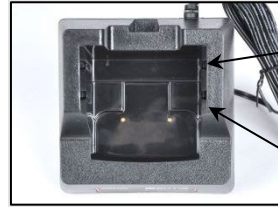

If the charger includes an insert, adjust the insert to ensure the battery contacts touch the charging contacts. Once the insert is placed into the desired position, a firm push down will secure it in place.

To prevent loss of the insert, keep it in the cradle in its most-used position.



Insert position: forward  
Insert side: 1



Lithium-ion battery  
Insert position: forward  
Insert side: 1



Slim extended lithium-ion battery  
Insert position: forward  
Insert side: 2



Extended range lithium-ion battery (aspirated shown).  
Also use this position for any diffusion instrument—deep-dimension battery combination.  
Insert position: rear  
Insert side: 1

**NOTE:** Do NOT touch the charger's battery contacts as contaminants and damage will inhibit charging.

**NOTE:** The charger is equipped with LED indicator. For further details on charger's LED patterns see [Appendix E](#).

Figure 8.3 Service Tasks

# Warranty

The Ventis Pro5 monitor is Guaranteed for Life™ as long as the instrument is supported by Industrial Scientific Corporation (excludes sensors, batteries, and filters). O2, LEL, CO, and H2S sensors and pumps are warranted for four years. All other sensors and batteries are warranted for two years.

## Limitation of Liability

**THE WARRANTY SET FORTH ABOVE IS STRICTLY LIMITED TO ITS TERMS AND IS IN LIEU OF ALL OTHER WARRANTIES, GUARANTEES, EXPRESS OR IMPLIED, ARISING BY OPERATION OF LAW, COURSE OF DEALING, USAGE OF TRADE OR OTHERWISE. INDUSTRIAL SCIENTIFIC MAKES NO OTHER WARRANTIES, EITHER EXPRESSED OR IMPLIED, INCLUDING BUT NOT LIMITED TO THE WARRANTIES OF MERCHANTABILITY OR FITNESS FOR PARTICULAR PURPOSE.**

SHOULD THE PRODUCT FAIL TO CONFORM TO THE ABOVE WARRANTY, BUYER'S ONLY REMEDY AND INDUSTRIAL SCIENTIFIC'S ONLY OBLIGATION SHALL BE, AT INDUSTRIAL SCIENTIFIC'S SOLE OPTION, REPLACEMENT OR REPAIR OF SUCH NON-CONFORMING GOODS OR REFUND OF THE ORIGINAL PURCHASE PRICE OF THE NONCONFORMING GOODS.

IN NO EVENT WILL INDUSTRIAL SCIENTIFIC BE LIABLE FOR ANY OTHER SPECIAL, INCIDENTAL, CONSEQUENTIAL, PUNITIVE OR OTHER SIMILAR DAMAGES, INCLUDING LOSS OF PROFIT OR LOSS OF USE, ARISING OUT OF THE SALE, MANUFACTURE OR USE OF ANY PRODUCTS SOLD HEREUNDER WHETHER SUCH CLAIM IS PLEADED IN CONTRACT OR IN TORT, INCLUDING STRICT LIABILITY IN TORT AND WHETHER INDUSTRIAL SCIENTIFIC HAS BEEN ADVISED OF THE POTENTIAL FOR SUCH DAMAGES. Industrial Scientific's total liability hereunder from any cause whatsoever (except liability from personal injury caused by Industrial Scientific's negligence), whether arising under contract, warranty, tort (including negligence), strict liability, products liability or any other theory of liability, will be limited to the lesser of Buyer's actual damages or the price paid to Industrial Scientific for the Products that are the subject of Buyer's claim. All claims against Industrial Scientific must be brought within one year after the cause of action arises, and Buyer expressly waives any longer statute of limitations.

It shall be an express condition to Industrial Scientific's warranty that all products be carefully inspected for damage by Buyer upon receipt, be properly calibrated for Buyer's particular use, and be used, repaired, and maintained in strict accordance with the instructions set forth in Industrial Scientific's product literature. Repair or maintenance by non-qualified personnel will invalidate the warranty, as will the use of non-approved consumables or spare parts. As with any other sophisticated product, it is essential and a condition of Industrial Scientific's warranty that all personnel using the products be fully acquainted with their use, capabilities and limitations as set forth in the applicable product literature.

Buyer acknowledges that it alone has determined the intended purpose and suitability of the goods purchased. It is expressly agreed by the parties that any technical or other advice given by Industrial Scientific with respect to the use of the goods or services is given without charge and at Buyer's risk; therefore, Industrial Scientific assumes no obligations or liability for the advice given or results obtained.

# Appendix A

## Supplemental Information about Gases and Sensors

### Toxic Gases

A sensor is designed to detect for and measure the presence of a particular gas, the "target gas"; however, it may also respond to other gases. When this is the case, the sensor is said to have "cross-sensitivity" to another gas, which will interfere with the target-gas readings. Table A.1 provides insight to the levels of cross sensitivity that can exist and whether a nontarget gas will have the effect of adding to or subtracting from the target-gas readings.

For example, a site is being monitored for H<sub>2</sub>S; the air also contains NO<sub>2</sub>. According to table A.1, the H<sub>2</sub>S sensor will respond to NO<sub>2</sub>, so the H<sub>2</sub>S readings will account for both gases. Because the NO<sub>2</sub> cross-sensitivity value is negative (-25%), its presence will *subtract from* the H<sub>2</sub>S readings, which will generate an H<sub>2</sub>S reading that is *lower* than the actual concentration of H<sub>2</sub>S contained in the air sample.

When a cross-sensitivity value is positive, the opposite will happen. When a gas has a positive cross-sensitivity value, it will add to a sensor's target gas reading, which will generate a reading that is higher than the actual concentration of the target gas contained in the air sample.

Note: For information about the calibration gasses visit [www.indsci.com/en/explore/calibration-gas-and-reference-chart](http://www.indsci.com/en/explore/calibration-gas-and-reference-chart).

Table A.1 Cross-sensitivity guidelines (%)

Target Gas	Sensor								
	CO	CO High	CO/H <sub>2</sub> Low	H <sub>2</sub>	H <sub>2</sub> S	SO <sub>2</sub>	NO <sub>2</sub>	HCN	NH <sub>3</sub>
CO	100	100	100	20	1	1	0	0	0
H <sub>2</sub> S	5	5	5	20	100	1	-40	10	25
SO <sub>2</sub>	0	0	5	0	20	100	0	—	-40
NO <sub>2</sub>	-5	-5	5	0	-25	-165	100	-70	-10
Cl <sub>2</sub>	-10	-10	0	0	-20	-25	10	-20	-50
ClO <sub>2</sub>	—	—	—	—	—	—	—	—	—
HCN	15	15	—	30	—	50	1	100	5
HCl	3	3	—	0	—	5	0	0	0
PH <sub>3</sub>	—	—	—	—	—	—	—	425	—
NO	25	25	40	30	-0.2	1	5	-5	0
H <sub>2</sub>	22	22	3	100	0.08	0.5	0	0	0
NH <sub>3</sub>	0	0	0	0	0	0	0	0	100

The values supplied above are estimates. They generally apply only to new sensors used for monitoring gases in these environmental conditions: 20 °C (68 °F), 50% RH, and 1 atm (101 kPa). Values are subject to change.

"—" indicates no available data.

## Combustible Gases

Tables A.2 and A.3 provide the LEL for select combustible gases as they apply to specific sensors. These tables also provide correlation factors that can help determine the percentage LEL when the actual gas differs from the gas that was used to calibrate the instrument.

For example, if the instrument reads 10% LEL in a pentane atmosphere, and was calibrated to methane, the actual percentage LEL is determined as follows:

1. Locate the table cell where the sample gas (pentane) intersects with the calibration gas (methane).
2. Multiply the cell's value (2.02) by the unit's LEL reading (10%) to calculate the actual concentration of 20.2% LEL.

Table A.2 LEL correlation factors for the sensors 17155304-K, -L, and -M

Sample gas	LEL (% vol)	Calibration gas					
		Butane	Hexane	Hydrogen	Methane	Pentane	Propane
Acetone	2.5%	1.00	0.70	1.70	1.70	0.90	1.10
Acetylene	2.5%	0.70	0.60	1.30	1.30	0.70	0.80
Benzene	1.2%	1.10	0.80	1.90	1.90	1.00	1.20
Butane	1.9%	1.00	0.58	1.78	1.67	0.83	1.03
Ethane	3.0%	0.80	0.60	1.30	1.30	0.70	0.80
Ethanol	3.3%	0.89	0.52	1.59	1.49	0.74	0.92
Ethylene	2.7%	0.80	0.60	1.40	1.30	0.70	0.90
Hexane	1.1%	1.71	1.00	3.04	2.86	1.42	1.77
Hydrogen	4.0%	0.56	0.33	1.00	0.94	0.47	0.58
Isopropanol	2.0%	1.10	0.90	2.00	1.90	1.00	1.20
Methane <sup>a</sup>	5.0%	0.60	0.35	1.06	1.00	0.50	0.62
Methanol	6.0%	0.60	0.50	1.10	1.10	0.60	0.70
Nonane	0.8%	2.22	1.30	3.95	3.71	1.84	2.29
Pentane	1.4%	1.21	0.71	2.15	2.02	1.00	1.25
Propane	2.1%	0.97	0.57	1.72	1.62	0.80	1.00
Styrene	0.9%	1.30	1.00	2.20	2.20	1.10	1.40
Toluene	1.1%	1.53	0.89	2.71	2.55	1.26	1.57
Xylene	1.1%	1.50	1.10	2.60	2.50	1.30	1.60
JP-4	—	—	—	—	—	1.20	—
JP-5	—	—	—	—	—	0.90	—
JP-8	—	—	—	—	—	1.50	—

<sup>a</sup>LEL (% vol) is 4.4% for applications relying on ATEX Performance EN 60079-29-1 and certificate FTZU 18 ATEX 0083.

Table A.3 LEL correlation factors<sup>a</sup> for the sensor 17155304-U, 17155304-UA

Sample gas	LEL (% vol)	Calibration gas
		Propane
Acetone	2.5	3.28
Butane	1.9	0.97
Chloromethane	8.1	4.97
Cyclopentane	1.1	1.62
Dichloroethane	5.4	8.57
Ethane	3.0	1.01
Ethanol	3.5	1.65
Ethyl Acetate	2.0	1.69
Ethylene	2.7	3.43
Ethylene Oxide	3.0	0.845
Hexane	1.1	0.8
Isopropanol	2.0	1.43
Methane	5.0	3.0
Methanol	6.0	2.22
Methyl ethyl ketone	1.4	1.87
Pentane	1.4	0.89
Propylene	2.4	1.69
Toluene	1.1	1.18
Xylene	1.1	1.51

<sup>a</sup>These factors only apply to gas concentrations expressed in % volume terms and up to 2.5%vol. These factors may vary from sensor to sensor with tolerance of  $\pm 25\%$  deviation.

*Note:* LEL correlation-factor accuracy may change without notice and is impacted by exposure to sensor inhibitors or poisons, sensor aging, the gas-detection applications and environment, and other factors. Calibrate instruments using the intended target gas when feasible and validate correlation factors as needed.

*Note:* Refer to EN 60079-20-1 to convert test and calibration gas concentrations from % LEL to % volume fraction.

# Appendix B

## How to program a wi-fi battery-equipped Ventis Pro

1. On your cell phone, install the iAssign® App from the Apple app or Google Play store.

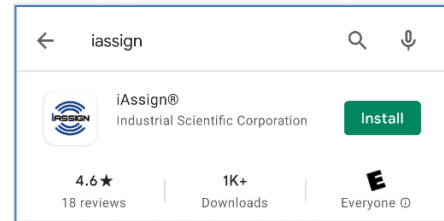

2. Open the iAssign app:

- An iAssign “splash” screen will briefly display the first time you open the app, or if you tap on “HELP”.
- After the splash screen dissolves, *Tag* will be selected.
- Tap *Wifi Card* to access wi-fi network settings.

*Note:* You can use this screen to program an iAssign tag or an iAssign card.

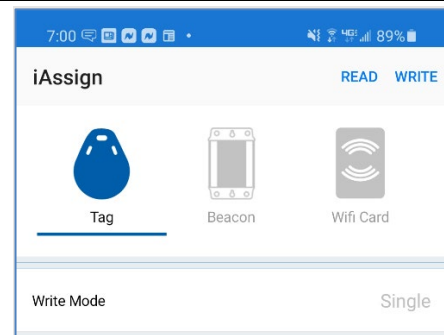

3. On the Wifi Card screen, enter values as needed for network settings:

- Enter a value for the *Network* identifier, up to 32 characters.
  - For example, *wifi*, *guestwifi*, etc.
- Select a value for the *Security* type:
  - Open
  - WEP
  - WPA or WPA2

*Note:* If you select WPA or WPA2, you will be prompted to supply a password. The password *cannot* contain the symbols “=” or “.”.
- Select the *IP Configuration* type: DHCP or Static IP.
  - For DHCP, the IP address is *automatically* assigned.
  - For Static IP, you will also need to specify these settings:
    - Network Mask
    - IP Address
    - Gateway
    - DNS Server
- After updating all needed settings, tap *WRITE* at the top of the screen.
- A prompt now displays the identifiers you are about to write to an iAssign tag or card.

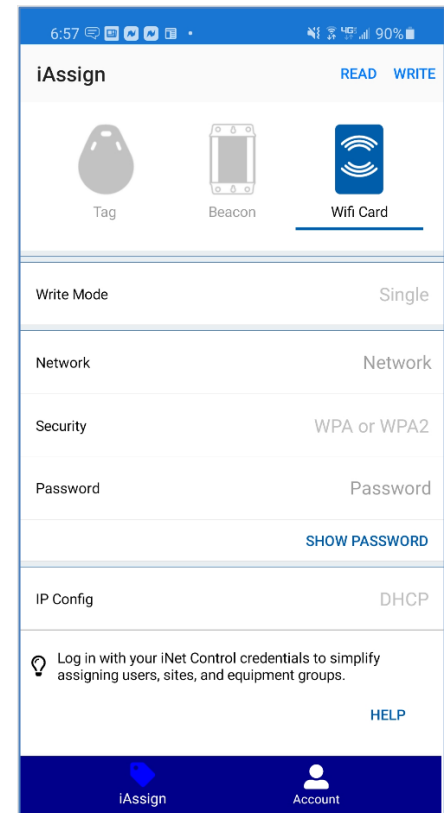

---

4. Tap an iAssign tag or card to the NFC target on the back of your smart phone.



*Note:* The location of the NFC target on a smart phone can vary, consult the phone's product manual or website for more information.

The wi-fi network settings specified in the previous steps should now be programmed to the tag or card.



---

5. Updating network settings on the Ventis Pro:

- On the Ventis Pro, press  to navigate from the home screen to the network screen.
- On the network screen press  to "Update".
- The prompt "Tap the NFC tag to update Credentials" displays on the Ventis Pro's screen.

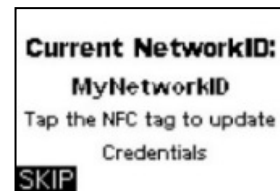
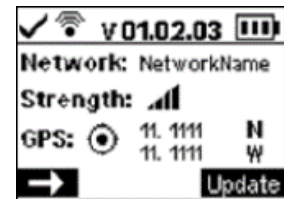
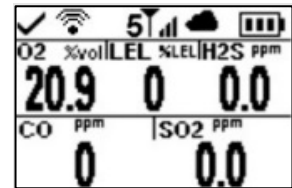

---

6. Tap the programmed iAssign tag or card to the instrument's speaker to update the network values on the Ventis Pro.

The Network ID displayed on the instrument is updated based on the values programmed to the iAssign tag or card.



# Appendix C

## Marking Requirements

### ATEX Markings

Industrial Scientific Corp.  
15205 USA  
VENTIS Pro SERIES  
DEMKO 15 ATEX 1571  
FTZU 18 ATEX 0083  
FTZU 18 E 0010  
Ex da ia IIC T4 Ga  
Ex db ia IIC T4 Gb with IR sensor installed  
Ex da ia I Ma  
Ex db ia I Ma with IR sensor installed  
 $-40^{\circ}\text{C} \leq \text{Ta} \leq +50^{\circ}\text{C}$   
 $-20^{\circ}\text{C} \leq \text{Ta} \leq +50^{\circ}\text{C}$  with IR sensor installed  
IP 64

### Aspirated Configuration

Use only replaceable battery pack P/N 17148313-1.  
Do Not Recharge or Replace battery in Hazardous Locations.  
Charging contact parameters: Um = 6.2V  
[Serial Number] [Month/Year of Production]

### Diffusion Configuration

Use only replaceable battery pack P/N 17148313-1, 17157350-X1, 17159022-X1, or 17134453-X1  
Do Not Recharge or Replace battery in Hazardous Locations.  
Charging contact parameters: Um = 6.2V  
[Serial Number] [Month/Year of Production]

### IECEX Markings

Industrial Scientific Corp.  
15205 USA  
VENTIS PRO SERIES  
IECEX UL15.0114  
IECEX FTZU 21.0001  
Ex da ia IIC T4 Ga, Ex db ia IIC T4 Gb with IR sensor installed  
 $-40^{\circ}\text{C} \leq \text{Ta} \leq +50^{\circ}\text{C}$   
 $-20^{\circ}\text{C} \leq \text{Ta} \leq +50^{\circ}\text{C}$  with IR sensor installed  
 $-20^{\circ}\text{C} \leq \text{Ta} \leq +50^{\circ}\text{C}$   
IP 64

### Aspirated Configuration

Use only replaceable battery pack P/N 17148313-1.  
Do Not Recharge or Replace battery in Hazardous Locations.  
Charging contact parameters: Um = 6.2V  
[Serial Number] [Month/Year of Production]

### Diffusion Configuration

Use only replaceable battery pack P/N 17148313-1, 17157350-X1, 17159022-X1, or 17134453-X1  
Do Not Recharge or Replace battery in Hazardous Locations.  
Charging contact parameters: Um = 6.2V  
[Serial Number] [Month/Year of Production]

# ATEX, and Workplace Atmosphere Gas Performance

The firmware version 5.00.18 is certified for use according to FTZÚ 18 E 0010 or FTZÚ 18 ATEX 0083 for gas performance. In the event of a firmware change, the applicable measurements according to the certificates will no longer be valid.

Only sensors and gas measurements shown below are certified to the standards and certificates indicated.

## Oxygen, Long-life (O<sub>2</sub>)

- Sensor part number 17155304-YA
- EN 50104:2019+A1:2023
- FTZÚ 18 E 0010

## Methane, 0-4.4% vol (CH<sub>4</sub>)

- Sensor part number 17155304-LA
- EN 60079-29-1:2016
- FTZÚ 18 ATEX 0083
- IECEx FTZU 21.0001

## Hydrogen Sulfide, 0-500 ppm (H<sub>2</sub>S)

- Sensor part number 17155306-2A
- EN IEC 62990-1:2022+A11:2022 SM
- FTZÚ 18 E 0010
- IECEx FTZU 21.0001

## Carbon Monoxide, 0-1000 ppm (CO)

- Sensor part number 17155306-1A
- EN 45544-1:2015
- EN 45544-3:2015
- FTZÚ 18 E 0010
- IECEx FTZU 21.0001

## Carbon Dioxide, 0-5% vol (CO<sub>2</sub>)

- Sensor part number 17155304-UA
- EN IEC 62990-1:2022+A11:2022 SM
- FTZÚ 18 E 001

## Applied Accessories

- 18108191 Single-Unit Charger
- 18108209 Single-Unit Charger/Datalink
- 18108651 Single-Unit Automotive Charger, 12VDC
- 18108652 Single-Unit Truck-Mount Charger, 12VDC, with Cigarette Adapter
- 18108653 Single-Unit Truck-Mount Charger, 12VDC, Hard Wired
- 18108650-A Ventis 6-Unit Charger
- 18109327-162 DSXi Docking Station for Ventis Pro
- 17148313-1 Li-Ion battery pack for aspired configuration
- 17157350-XX Li-Ion battery pack for diffusion configuration

*Note:* The first 'X' indicates color: 0 for black (battery cover is only black). The second 'X' denotes approval: 1 for UL, CSA, ATEX, IECEx; 2 for MSHA; 3 for China EX; 4 for ANZEx; 5 for INMETRO.

- 17152455 Calibration cup

# Appendix D

## Certification Standards











Table D.1 Applicable Certification Standards

15 ATEX 1571	IECEX UL15.0114	E218330 Vol. 1 Sec. 12	UL22UKEX2684
EN IEC 60079-0:2018	IEC 60079-0:2017, 7 <sup>th</sup> Edition	UL 913, 8 <sup>th</sup> Edition	EN IEC 60079-0:2018
EN 60079-1:2014	IEC 60079-1:2014, 7 <sup>th</sup> Edition	UL 60079-0, 7 <sup>th</sup> Edition	EN 60079-1:2014
EN 60079-11:2012	IEC 60079-11:2011, 6 <sup>th</sup> Edition	UL 60079-1, 7 <sup>th</sup> Edition	EN 60079-11:2012
EN 50303:2000	IEC 60079-26:2021, 4 <sup>th</sup> Edition	UL 60079-11, 6 <sup>th</sup> Edition	EN 50303:2000
EN 60079-26:2015			EN 60079-26:2015

# Appendix E

## Alarms, Possible Causes, and Relative Signal Intensity

Table E.1 Alarms with symbols and signal intensity

Alarm level	Signal intensity
Event types	Event symbol
High Alarm	
Gas present (over-range event)	<b>OR,-OR</b>
Gas present (high-alarm event)	
STEL event	<b>STEL</b>
Man down	
Panic	
System error (408 shown)	<b>ERROR 408</b>
Critical low battery	
Proximity	Access Denied
Sensor failure	<b>F</b>
Zero fail	<b>ØF</b>
Calibration fail	<b>CAL and F</b>
Pump Fault	Pump Fault 
Low Alarm	
Gas present (low-alarm event)	
TWA event	<b>TWA</b>
Peer High Alarm	
Peer gas present (high-alarm event)	
Peer STEL	<b>STEL</b>
Peer man down	

Peer panic



Peer Low Alarm



Peer gas present (low-alarm event)



TWA

TWA

## Charger/Datalink Indicator

Table E.2 Charging/Datalink Pattern

### Charging Indicator



18108191	Ventis Single-Unit Charger	The charger displays solid amber when the instrument is charging. Check the monitor's battery level indicator to confirm the battery charge level. No light is displayed when instrument is fully charged.
18108209	Ventis Single-Unit Charger/Datalink	
18108650-A	Ventis 6 -Unit Charger	
18108651	Ventis Single-Unit Automotive Charger 12V DC	
18108652	Ventis Single-Unit Truck Mount Cgarger, 12VDC with Cigeratte Adapter	
18108653	Ventis Single-Unit Truck Mount Cgarger, 12VDC, Hard Wired	

### Datalink Indictor



18108209	Ventis Single-Unit Charger/Datalink	The datalink displays solid green when it is connected.
----------	-------------------------------------	---

# Contact Information

## Industrial Scientific Corporation

1 Life Way  
Pittsburgh, PA 15205-7500 USA  
Web: [www.indsci.com](http://www.indsci.com)  
Phone: +1 412-788-4353 or 1-800-DETECTS (338-3287)  
E-mail: [info@indsci.com](mailto:info@indsci.com)  
Fax: +1 412-788-8353

## Industrial Scientific France S.A.S.

11D Rue Willy Brandt  
62002 Arras Cedex, France  
Web: [www.indsci.com](http://www.indsci.com)  
Téléphone : +33 (0)1 57 32 92 61  
E-mail: [info@eu.indsci.com](mailto:info@eu.indsci.com)  
Fax: +33 (0)1 57 32 92 67

## 英思科传感仪器（上海）有限公司

地址：中国上海市浦东金桥出口加工区桂桥路290号  
邮编：201206  
电话：+86 21 5899 3279  
传真：+86 21 5899 3280  
E-mail：[iscapinfogroup@indsci.com](mailto:iscapinfogroup@indsci.com)  
网址：[www.indsci.com](http://www.indsci.com)  
服务热线：+86 400 820 2515

To locate a nearby distributor of our products or an Industrial Scientific service center or business office, visit us at [www.indsci.com](http://www.indsci.com).

Rendez-vous sur notre site Web [www.indsci.com](http://www.indsci.com), si vous voulez trouver un distributeur de nos produits près de chez vous, ou, si vous recherchez un centre de service ou un bureau Industrial Scientific.

Besuchen Sie uns unter [www.indsci.com](http://www.indsci.com), um einen Vertriebshändler unserer Produkte oder ein Servicecenter bzw. eine Niederlassung von Industrial Scientific zu finden.

Para buscar un distribuidor local de nuestros productos o un centro de servicio u oficina comercial de Industrial Scientific, visite [www.indsci.com](http://www.indsci.com).

如需查找就近的产品经销商或 Industrial Scientific 服务中心或业务办事处，请访问我们的网站 [www.indsci.com](http://www.indsci.com)。

**INDUSTRIAL**  

---

**SCIENTIFIC**